

CECW-ED Engineer Manual 1110-2-2602	Department of the Army U.S. Army Corps of Engineers Washington, DC 20314-1000	EM 1110-2-2602 30 September 1995
	Engineering and Design PLANNING AND DESIGN OF NAVIGATION LOCKS	
	Distribution Restriction Statement Approved for public release; distribution is unlimited.	

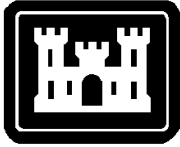

EM 1110-2-2602
30 September 1995

**US Army Corps
of Engineers**

ENGINEERING AND DESIGN

Planning and Design of Navigation Locks

ENGINEER MANUAL

AVAILABILITY

Copies of this and other U.S. Army Corps of Engineers publications are available from National Technical Information Service, 5285 Port Royal Road, Springfield, VA 22161. Phone (703)487-4650.

Government agencies can order directly from the U.S. Army Corps of Engineers Publications Depot, 2803 52nd Avenue, Hyattsville, MD 20781-1102. Phone (301)436-2065. U.S. Army Corps of Engineers personnel should use Engineer Form 0-1687.

UPDATES

For a list of all U.S. Army Corps of Engineers publications and their most recent publication dates, refer to Engineer Pamphlet 25-1-1, Index of Publications, Forms and Reports.

DEPARTMENT OF THE ARMY
U.S. Army Corps of Engineers
Washington, DC 20314-1000

EM 1110-2-2602

CECW-ED

Manual
No. 1110-2-2602

30 September 1995

Engineering and Design
PLANNING AND DESIGN OF NAVIGATION LOCKS

1. Purpose. This manual is issued for guidance of engineers and design offices within the Corps of Engineers engaged in the planning, engineering layout, analysis, and design of navigation locks for civil works navigation projects on inland waterways.

2. Applicability. This engineer manual applies to HQUSACE elements and USACE commands having responsibilities for the design and construction of civil works navigation projects.

FOR THE COMMANDER:



ROBERT H. GRIFFIN
Colonel, Corps of Engineers
Chief of Staff

CECW-ED

Manual
No. 1110-2-2602

30 September 1995

**Engineering and Design
PLANNING AND DESIGN OF NAVIGATION LOCKS**

Table of Contents

Subject	Paragraph	Page	Subject	Paragraph	Page
Chapter 1			Tied-Back Concrete 4-4		
Introduction			Steel Sheet Piling 4-5		
Purpose	1-1	1-1	Earth Chamber	4-6	4-3
Applicability	1-2	1-1	Lock Components	4-7	4-4
Policy	1-3	1-1	Chapter 5		
References	1-4	1-1	Layout and Design		
Scope	1-5	1-1	General	5-1	5-1
Chapter 2			Lock Dimensions	5-2	5-1
General Considerations for			Filling and Emptying Systems	5-3	5-4
Project Development			Lock Walls	5-4	5-8
General	2-1	2-1	Approach Walls	5-5	5-9
Evaluation of Existing			Lock Sills	5-6	5-11
Navigation Locks	2-2	2-1	Gate Types and Locations	5-7	5-13
Risk and Uncertainty --			Lock Closure	5-8	5-13
Sensitivity Analysis	2-3	2-2	Galleries and Cable Trenches	5-9	5-15
Environmental and Aesthetic			Lock Wall Accessories	5-10	5-15
Considerations	2-4	2-3	Tow Haulage Unit and		
Chapter 3			Movable Kevel	5-11	5-16
Project Engineering			Chapter 6		
Considerations			Appurtenant Structures and		
General	3-1	3-1	Other Considerations		
Information Investigations	3-2	3-1	General	6-1	6-1
Site Selection	3-3	3-2	Lock Buildings	6-2	6-1
Lock Size and Configuration	3-4	3-5	Esplanade	6-3	6-2
Project Engineering Alternative			Access Bridge	6-4	6-2
Studies	3-5	3-9	Emergency Access	6-5	6-2
Engineering Considerations	3-6	3-10	Service Bridge	6-6	6-2
Chapter 4			Public Access, Observation Platforms,		
Description of Locks and			and Visitor Centers	6-7	6-3
General Terms			Provisions for the Disabled	6-8	6-3
General	4-1	4-1	Elevators	6-9	6-3
Mass Concrete	4-2	4-1	Lock Lighting	6-10	6-3
Reinforced Concrete Lock					
Structure	4-3	4-1			

Subject	Paragraph	Page	Subject	Paragraph	Page
Chapter 7					
Gates, Valves, and Bulkheads					
General	7-1	7-1	Floating Mooring Bitts	10-2	10-1
Lock Gates	7-2	7-1	Line Hooks and Check Posts	10-3	10-2
Culvert Valves	7-3	7-2	Tow Haulage Unit and Movable Kevel	10-4	10-2
Lock Chamber Bulkhead Closures	7-4	7-3	Wall Armor and Corner Protection	10-5	10-2
Chapter 8			Guardrails	10-6	10-2
Loads			Parapet Walls	10-7	10-3
General	8-1	8-1	Grating	10-8	10-3
Hydrostatic	8-2	8-1	Trash Racks	10-9	10-3
Earth Loads	8-3	8-2	Second Placement Concrete	10-10	10-3
Earthquake or Seismic	8-4	8-3	Gauges	10-11	10-3
Impact	8-5	8-3	Distance Markers	10-12	10-3
Hawser Loads	8-6	8-3	Instrumentation (Structural)	10-13	10-4
Ice and Debris	8-7	8-3	Air Bubbler System	10-14	10-4
Wave Pressure	8-8	8-3	Chapter 11		
Wind Loads	8-9	8-4	Design for Operation, Safety, and Maintenance		
Gate Loads and Bulkhead Loads	8-10	8-4	General	11-1	11-1
Crane, Equipment, Machinery, and Appurtenant Items	8-11	8-4	Design for Operation	11-2	11-1
Cofferdam Tie-in Load	8-12	8-4	Design for Safety	11-3	11-4
Sheet Pile Cutoff Loads	8-13	8-4	Design for Maintenance	11-4	11-6
Monolith Joint Loads	8-14	8-4	Chapter 12		
Superstructure and Bridge Loads	8-15	8-4	List of Plates		
Temperature	8-16	8-4	Appendix A		
Hydrodynamic Loads	8-17	8-6	References		
Cyclic Loads	8-18	8-6	Appendix B		
Internal Hydrostatic Pore Pressure in Concrete	8-19	8-6	Wall Loadings - Check Lists		
Chapter 9			Appendix C		
Analysis and Design Criteria			Semiautomatic Central Control System		
Stability Analysis	9-1	9-1	Appendix D		
Structural Analysis	9-2	9-1	Case Histories		
Foundation Design and Soil/Structure Interaction	9-3	9-2			
Reinforcing Design	9-4	9-3			
Chapter 10					
Design of Lock Wall Accessories					
General	10-1	10-1			

Chapter 1 Introduction

1-1. Purpose

This manual is issued for guidance of engineers and design offices within the Corps of Engineers engaged in the planning, engineering layout, analysis, and design of navigation locks for civil works navigation projects on inland waterways.

1-2. Applicability

This engineer manual applies to HQUSACE elements and USACE commands having responsibilities for the design and construction of civil works navigation projects.

1-3. Policy

This guidance will be followed in the design and layout of navigation locks, unless site-specific conditions or proposed innovative designs warrant deviations from the guidance contained in this manual. Deviations from this guidance should be approved by CECW-ED and subsequently documented in design memoranda.

1-4. References

Required and related publications are listed in Appendix A.

1-5. Scope

a. General. This engineer manual provides guidance and criteria for the planning, engineering layout, and design of navigation locks and appurtenant structures. These structures may include gatebay and lock walls, approach walls, sills, lock floors, miscellaneous walls, river training structures, galleries and cable trenches, lock wall accessories, control houses, visitor access, handicapped access, and administration and maintenance complexes. This manual is structured so that Chapters 1 through 3 contain planning and project engineering guidelines, while Chapters 4 through 11 provide detailed design guidance. Chapter 12 describes guidance for the operation, safety, and maintenance of the locks which contribute to the efficiency and safety of operation of the lock and the life-cycle durability of the project. The manual's appendices contain references, design and planning information, line-item list of quantities, scheduling and budgeting guidelines, a loadings checklist, and sample computations.

b. Other guidance. The design of structural steel lock gates is covered in EM 1110-2-2703. Detailed design of concrete U-frame and W-frame locks is contained in other engineering guidance manuals cited in Appendix A. Analysis of massive reinforced concrete structures for nonlinear, incremental structural analysis (NISA) and reliability evaluation of existing navigation structures are also cited in Appendix A.

Chapter 2 General Considerations for Project Development

2-1. General

This chapter provides an overview of the engineering, policy, and planning guidance applicable to developing a project plan for navigation improvements associated with the planning, design, construction, and major rehabilitation of navigation locks.

a. Project team. The planning, engineering layout, and design of navigation locks as part of the overall development of a project plan for navigation projects is a complex, multidisciplinary planning and engineering effort. This effort involves the contributions from many public and private interests including local, state, and federal agencies; planners; design engineers; environmental engineers; natural habitat biologists; operations engineers; and construction engineers. It has been found through experience that the planning and design process works most efficiently if these participating interests work through a multidisciplinary planning-engineering team effort. In this effort, the project team receives and evaluates input to develop the project plan and recommendations for implementation. Thus, a project team should be organized at the initiation of the reconnaissance phase for a proposed navigation project. This team should include key personnel from planning, engineering, operations, construction, and project management. This project team should function through the entire life cycle of the project including planning, design, construction, and operation.

b. Navigation lock planning principles and guidelines. The objective of water resources planning is to contribute to national economic development (NED) consistent with protecting the environment of the United States, according to national environmental statutes, applicable executive orders, and other federal planning requirements. The planning process consists of the following steps:

(1) Problem identification. This step specifies the water and related land resources problems and opportunities associated with the federal interest in navigation concerns.

(2) Data gathering. Data gathering involves inventory, forecast, and analysis of water and land resource conditions within the planning area relevant to the navigation project problems and opportunities.

(3) Alternative studies. This step involves formulation and evaluation of the effects of the alternative plans. The NED plan reasonably maximizes net NED benefits, consistent with the federal objective. Other alternative plans should be developed to address other concerns not listed in the NED plan.

(4) Comparison of alternative plans. In this step, alternative plans and studies are compared in order to draw further conclusions.

(5) Recommendations. Based on conclusions, a recommended plan is selected and presented.

c. Design considerations during planning. During the planning stage, design considerations include issues of safety, efficiency, reliability, and cost effectiveness. Cost considerations should also incorporate the trade-off between initial cost and cost of operation and maintenance. The engineering guidance applicable to navigation project design is contained in ER 1110-2-1404, ER 1110-2-1457, and ER 1110-2-1458. Planning guidance specifies similar, but not identical, considerations for formulating alternative plans to identify the project that reasonably coordinates net benefits with environmental protection. Project optimization requires interaction between engineering, design, economic evaluation, and the environment. ER 1110-2-1150 specifies the engineering responsibilities for life-cycle cost optimization during studies and subsequent phases of project implementation. Coordination of design and evaluation relies on planning guidance and on the engineering and design services that are provided to the planning effort.

2-2. Evaluation of Existing Navigation Locks

a. General. The existing lock and dam structures in the inland navigation system are a vital link in the national infrastructure. However, over 40 percent of these facilities are more than 50 years old, and the demands for rehabilitation are increasing. While the infrastructure is deteriorating, navigation traffic is increasing, thus creating a demand for larger, more efficient facilities. Therefore, the limited funds available for rehabilitation must be selectively invested to maximize navigation benefits. Projects in a river system are usually about the same age and have similar lock capacity. Historically, rehabilitation work has concentrated on relieving local congestion. As these facilities approach or exceed their design life, future rehabilitation decisions must focus on identifying and reconstructing the project features which are declining in reliability or on modifying a major component to enhance operational efficiency.

b. Background. In the past, evaluations of existing structures have been based on deterministic analyses using current design criteria. Even with the adaptations permitted by ETL 1110-2-310, the current stability criteria are more stringent than criteria used in the design of many existing projects. Frequently, structures which have performed satisfactorily for years do not conform to current design criteria, indicating that current criteria alone should not be used to judge the reliability of existing structures.

c. Criteria. Engineering criteria are needed for the purpose of evaluating existing projects, and they may differ from those used for designing new projects. The criteria should account for uncertainties in the investigations, testing, material properties, and analyses used in the rehabilitation decision process. Reliability assessments, based on probabilistic methods, provide more consistent results that reflect both the basis for design and the condition of the existing structure. Reliability methods are the basis for new engineering criteria for designing bridges and steel buildings, as well as for prioritizing the maintenance and replacement of bridges.

d. Guidance. For the assessment of existing structures where new navigation facilities may be added, reliability assessments based on probabilistic methods will be used to determine the rehabilitation necessary for the existing structures. Additional guidance, background, and references relating to reliability assessment and condition analysis of structures are available from the references in Appendix A. Guidance is provided in ETL 1110-2-321 and ETL 1110-2-532 for assessing the reliability of navigation structures and establishing an engineering basis for rehabilitation investment decisions. As these procedures mature and the associated methodology is developed, further guidance will be issued.

2-3. Risk and Uncertainty -- Sensitivity Analysis

During the evolution of a navigation lock design, the amount of uncertainty and risk should be reduced as more information becomes available from the refined analysis and evaluation of alternatives. This process should refine the accuracy of the project cost estimate. Frequently, the amount of risk and uncertainty is underestimated or not even considered during preliminary stages of project formulation, and the project cost estimate increases as the design is refined. However, the baseline cost estimate must be developed during the feasibility phase when this information is still preliminary. Thus, engineering processes and their effects during the design phases should be examined to determine the uncertainty inherent in the data or various assumptions used in the engineering

analysis and formulation of alternative plans. During development of the cost estimate, an engineering analysis should be formulated using the principles of risk and sensitivity analysis to estimate the appropriate contingencies to apply to the line item code of accounts. This procedure will ensure that the life-cycle project costs are established as a baseline for further design comparisons.

a. Uncertainty. In situations of uncertainty, potential outcomes cannot be described in objectively known probability distributions. The engineer's primary role in managing uncertainty is to identify the areas of sensitivity and clearly describe them so that decisions can be made on which parameters should be investigated in greater detail. For instance, during the feasibility stage for a navigation lock structure several sites may be under consideration; however, a foundation exploration program might be considered too expensive or time-consuming to define the foundation conditions for each of these sites. Thus, there may be a high degree of uncertainty of the founding elevation of the lock structures or the type of foundation required, pile or soil, which may have a high impact on the cost of the structures. Higher contingencies may be required for these line items to account for this degree of uncertainty. To reduce this uncertainty for a more determinate design, funds and time would have to be allocated to perform a foundation exploration and testing program for each site. Evaluation of the potential costs and benefits of alternative courses of action can aid in these investment decisions.

b. Risk. The potential outcome of risk situations can be described in reasonably well-known probability distributions such as the probability of particular flood events. For example, a risk analysis is necessary to determine the top of a cofferdam used to protect a navigation lock construction. The probability of overtopping the cofferdam at a certain elevation (cost of structure) can be compared to the damages associated with the frequency of flooding the cofferdam (cost of damages). This type of risk analysis can provide information for selecting the optimum height of cofferdam to minimize overall costs and/or time required for construction.

c. Reducing risk and uncertainty. Risk and uncertainty arise from measurement errors, lack of data, and the underlying variability of complex natural, physical, social, and economic situations. Reducing risk and uncertainty may involve increased engineering or construction costs or loss of benefits. The advantages and costs of reducing risk and uncertainty should be considered in the planning process. Additional information on risk and

uncertainty can be found in Institute for Water Resources (IWR) Report 92-R-1 and ETL 1110-2-532.

d. Methods of dealing with risk and uncertainty. The following methods are required to calculate risk and uncertainty:

(1) Collecting more detailed data through physical explorations, research and development, and improved analytical procedures.

(2) Increasing safety factors in design.

(3) Selecting conservative alternative designs with known performance characteristics.

(4) Reducing the irreversible or irretrievable commitments of resources.

(5) Performing a sensitivity analysis of the estimated benefits and costs of alternative courses of action.

2-4. Environmental and Aesthetic Considerations

a. General. This section presents considerations for blending a lock structure into the surrounding environment for appearance, natural habitat, environmental quality, and public acceptance. Some important design considerations include requirements for aesthetics; dredging fill and disposal; hazardous, toxic, and radioactive wastes (HTRW); habitat; and citizen involvement through public hearings.

b. Architectural. Incorporating architectural appearance into project design, including consideration of the visual quality of the project, is an important objective for design of locks. Navigation structures are monumental and have a large impact on the landscape of the natural rivers. These structures are highly visible, and if public access is provided, will generate much visitor attraction. The following references provide guidance for enhancing the aesthetics of Civil Works projects: ER 1105-2-100, EM 1110-2-38, EM 1110-2-301, EM 1110-2-1202, EM 1110-2-1204, and EM 1110-2-1205.

c. Aesthetic design. The following principles should be applied in defining the appropriate measures for aesthetic enhancement at Civil Works projects in all stages of project development.

(1) Project relationship. Any project features must be related to blending the project into the project setting and not aimed at "beautifying" the surrounding area.

(2) Structures. Structures such as locks and dams, and accompanying buildings should have neat, clean lines and an uncluttered appearance. The plan for lock structures should account for aesthetic factors such as appearance, color, and landscaping, as well as incorporating safety features into the design. In addition, the plan should include the location of safety railings, fencing, machinery and equipment layouts, power and communication lines, and poles and appurtenances. Considerations for enhancing a structure's appearance can range from selecting a material or color to using a specific type of railing. Architectural techniques and/or landscape plantings which may minimize the starkness of a structure can be used to create a visually pleasing appearance. The plans for the structure should incorporate artistic use of color, material selection, and texture and combinations. Also, including concrete finishes in the plans for the structure will improve its appearance to the general public. Machinery and other equipment can be located in architecturally pleasing structures or shrouds. In addition, consideration should be given to using concrete walls, parapets topped with railings, or metal railings instead of chain link fencing.

(3) Landscaping. Other unattractive areas can also be screened with landscape plantings. Landscape plantings must be limited to the land required for the project and plantings should not extend to adjacent property, even if the adjacent property is a public park or recreation area. All of these project considerations will allow the structures to blend with its surrounding environment.

(4) Project setting. The acceptability and compatibility of aesthetic features of project design are affected by the project setting and by the expectations of the users of the project. The land use in the area surrounding the project is an important consideration in determining the appropriate measures for aesthetics.

(5) Compatibility. All aesthetic measures must be designed so that they are fully compatible with the project purpose and in no way compromise the safety, integrity, or function of the project.

d. Hazardous, toxic, and radioactive wastes (HTRW).

(1) Site selection investigation. Prior to acquisition of any project lands, a site selection investigation should be conducted to determine if any HTRW violations exist on these lands. These investigations should search for the existence of any previous structures or land uses on that project site. Previous structures or uses which may

indicate potential environmental hazards include farms, gasoline stations, railroad yards, industrial plants, or military installations. If a real estate or title search indicates the existence of any installations which could result in HTRW, site studies should be initiated to determine if any HTRW exists. These evaluations should be a part of the reconnaissance phase and site-selection process.

(2) Reports. Results of the investigation should be covered in the reconnaissance and feasibility reports. These reports should include requirements for the HTRW restoration measures required before the land is acquired for project purposes.

e. Habitat.

(1) Protection of fish and wildlife. The planning stages of any project should incorporate a thorough study of the surrounding habitat for potential impact on the fish and wildlife.

(2) Construction considerations. Before initiating any project, engineers should account for the impact of construction activities on surrounding wildlife and infrastructure. The activities which may adversely affect the project area environment include the following:

- (a) Noise control during pile driving or blasting.
- (b) Control of rainwater or dewatering.
- (c) Control of other fluid waste during construction.
- (d) Disposal of excess dredge material.
- (e) Erosion control during construction.

(3) Mitigation. When wetlands are removed or disturbed, a plan for mitigation must be developed.

Chapter 3 Project Engineering Considerations

3-1. General

In previous decades, many inland and coastal rivers and waterways were developed for navigation with channelization or navigation lock and dam projects. However, the emphasis in this era is on the modernization, addition, or replacement of the components of the existing inland waterway system for increased efficiency and/or major rehabilitation of deteriorating parts of this infrastructure. Many of the lock and dam projects are approaching or have exceeded 50 years in age, and may require improvement or rehabilitation. The engineering considerations for navigation lock development or improvement identified in this chapter should be studied and presented in the feasibility report. More detailed engineering analysis should be provided in subsequent design memoranda.

3-2. Information Investigations

After a waterway or navigation project is proposed for navigation improvements, the first step in engineering is the information gathering stage. This stage should start during the reconnaissance stage, with the information presented in the feasibility report.

a. Characteristics and history. All available information should be collected and evaluated concerning the project such as existing characteristics, physical setting, surrounding infrastructure, social context, environmental resources, transportation modes, economic base, and past performance. An engineering assessment of a waterway for improvements should focus on existing and projected data for the following items:

- (1) The natural characteristics of the river, including its stability in a defined channel, the character of the riverbed, scouring or depository, slope of river valley, the riverbed soil profile, the underlying geology, and seismic zone activity.
- (2) The river basin hydrographic data, including project storms, rainfall, and runoff factors.
- (3) Hydraulic data with river hydrographs, including stage duration, stage velocities and stage discharge curves, low-water and flood-stage levels with their slopes, seasons, length of time each stage is prevalent, the regularity of streamflow cycle, and magnitude of sudden rises.

- (4) The normal channel dimensions, including over-bank areas, location of dikes, revetments, and natural or artificial barriers.

- (5) Climate, weather, and ice conditions.

- (6) Existing navigation upstream or downstream (typical tow size).

b. Maps and topography. Information needed for engineering a lock project should be obtained or developed on the topographical features, land use, and river developments of the immediate site and entire project area. If the required information cannot be easily located, surveys and mapping should be performed to show the data required for planning and design of the project. This information should include the following:

- (1) Topographic and hydrographic mapping of the site land and water areas with the appropriate scale for the level of study.

- (2) Location, elevation, and other information concerning cities and industrial developments.

- (3) Railroads, highways, power lines, pipelines, flood protection, levee districts, sewer outlets, power plants and water supply, and pumping stations.

- (4) Fishing and hunting preserves, channel soundings, high- and low-water marks, agricultural land use, and river gages.

- (5) Harbors, bridges, dams, dikes, wharves, pleasure resorts, and all other features that might be affected by the proposed project.

c. Real estate considerations. Numerous real estate considerations are associated with a navigation facility and those concerning the lock site itself may form only a small part of the picture. In the investigation phases, the government may need temporary access to private property to perform surveys and foundation exploration; to assess possible requirements for highway, railroad, and utility relocations; to determine access road alternatives; and for other reasons. In the site selection stage, temporary access will be needed at a number of locations to obtain adequate data for determining the best site for the structure. Project construction and/or operation purposes will require real estate for staging construction activities and for project-induced flooding of lands adjacent to the upstream channel, channel work, navigation structures,

access roads, and support facilities. Surveys should be performed to identify the need to mitigate damages from levee underseepage from changed pool conditions. Mitigation may involve compensating a landowner for estimated damages for changed industrial and agricultural land use over the project life. An alternative to mitigation may be the need for levees, pumping stations, and drainage structures to handle increased water levels and induced underseepage from changed pool conditions. Other considerations which may pose major concerns include the following:

- (1) Determining the types of right-of-way required (including easements and fee title properties).
- (2) Establishing the entity responsible for obtaining real estate and performing relocations.
- (3) Estimating the lead-times required to obtain rights-of-way and perform relocations.
- (4) Identifying lands for mitigation of changed environmental conditions.

3-3. Site Selection

Selection of alternative site locations is the next step in the project formulation.

a. General layout. Locks and the associated dam are integral parts, and the relation of both has to be considered when selecting lock site alternatives for a navigation project. The location of a navigation lock is determined by identifying and evaluating all feasible locations within the project area. In identifying the location, the following criteria should be evaluated: lock capacity, location of existing navigation structures (modification of existing structures or complete replacement at an alternate site), navigation efficiency and safety, visibility and straight approaches for vessels, foundation conditions, relative cost of structure, existence of public utilities, required relocations, lands available and suitable for construction staging, esplanade and general operations, and any other advantages for a particular site. An engineering determination should be made to confirm that the alternative site locations selected are feasible for navigation conditions and foundation qualities. Locks should be located in straight stretches of river with approaches aligned with the currents. For example, a location which produces cross-currents in the approaches or shoaling would be undesirable unless modified by dike work or channel relocation. On the other hand, when conditions warrant, there may be

an advantage in locating the lock in a side canal or cutoff to take advantage of natural river formations, reduce cofferdam staging, or bypass undesirable features. Specific guidance regarding hydraulic considerations is provided in EM 1110-2-1601 and in EM 1110-2-1604.

b. Lock capacity and layout. For input into the site selection evaluation, an integrated engineering and economic planning study needs to be performed to determine the number, size, capacity, and layout of the various lock alternatives.

- (1) Lock size and location.

(a) The number of locks and lock sizes for the desired capacity depends on the challenges involved in selecting the most efficient lock site. Different sites and configuration of locks may have different capacities because of differing site conditions such as navigation approaches, lock separation, incorporation into an existing structure, complete replacement, location in a canal or open river, and associated economic costs of the structures. The determination of commercial tonnage capacity required for a lock project is developed through economic studies of present and future commodity movement projections. Once the desired lock capacity is determined, then various lock sizes can be configured at the alternative sites to determine the costs of the navigation improvements. This integrated procedure is an iterative process between planners performing economic analysis, and project engineers conducting design and cost studies, in order to optimize the proposed navigation improvements.

(b) In most cases, the lock project will also require (unless it is located in a canal) a consideration of gated dam, ungated overflow dam, or navigable pass structure alternatives. These considerations involve complex design relationships that should be accounted for in the economic costs and alternative site selection process. The determination of pool and tailwater elevations for navigation will also impact the capacity and economic cost of the system as well as other requirements such as the need to control flowage damages. These requirements can make it a challenge to identify the most economical structures for a particular site.

(2) Traffic requirements. A comprehensive study of present and projected future traffic requirements, with particular emphasis upon lock size and time required for lockage, can indicate that one lock is sufficient to satisfy the 50-year economic capacity requirement. However, any cause for closure, such as emergency shut-down,

accident, or maintenance, for this one lock may make this project the head of navigation for as long as the lock is closed. If this condition is not acceptable, then two locks might be justified for the project to provide alternate access. Flights of two or more locks (locks in tandem) are sometimes used for unusually high lifts in excess of 100 ft, for water conservation, or for foundation conditions which are not adequate for a single lift. However, where site conditions permit, it will be more economical to provide the total lift in one chamber. In addition, single lifts will certainly be less expensive for the users because of decreased transit time and entail less maintenance and operating costs. However, the design of a single lock with over 110-ft lift is unprecedented and will require careful hydraulic, structural, and foundation design to ensure satisfactory performance.

c. Navigation requirements. For a canalized waterway to be developed for maximum use, operating restrictions and hazardous reaches should be eliminated by river regulating works, channel relocations, and selection of pool elevations. To ensure continuous use of the waterway, the locks should be located and operated for continuous navigation. The following factors should be considered during the economic, capacity, and design studies for lock configuration:

- (1) Visibility.
- (2) Ease of approach.
- (3) Few lockage restrictions, such as double lockages.
- (4) Provisions for prompt lockage.
- (5) Adequate approach channel with low velocities.
- (6) Elimination of crosscurrents which would tend to draw vessels away from lock entrance.
- (7) Duplicate gates or closure to prevent downtime due to emergency and accident.
- (8) Elimination of lockage in congested traffic areas.
- (9) Adequate horizontal and vertical navigational clearances for bridges at or near locks.
- (10) Adequate mooring facilities and maneuvering areas.

d. Planning criteria for navigation requirements. The most important considerations involve the effects of stream characteristics, streamflow, and visibility on navigation.

(1) Effects of stream characteristics on navigation. The characteristic of the river should be taken into account for the design of the navigation project. Straight stretches of rivers are usually less difficult to navigate for approaches to locks; thus, straight stretches one or two miles above and below are desirable locations for locks (if all other requirements are satisfied). The locks are usually located at one end of a dam to provide access to operation, increase the area available for flood discharges, and use the natural protection to navigation offered by a shoreline. If dual locks are considered, then there may be an operational advantage in separating the locks with a spillway in between. The depth of the channel lessens toward the banks on a straight reach or inside of curve but deepens on the outside of a curve. If the lock is located in a reach that has a tendency to shoal, the necessity to dredge may add unacceptable maintenance costs over the life of the project to provide the project depth during low-water stages. Because continual maintenance dredging in the approaches to a lock is expensive, this tendency should be eliminated with addition of river training structures during the site selection and design process. Shoaling and scour characteristics of the stream both naturally and with addition of the improvements should be determined using hydraulic theoretical analysis procedures verified by hydraulic navigation model testing.

(2) Effects of streamflow on navigation. The flow characteristics of the stream in the vicinity of a lock should be evaluated during the site selection to select a feasible location of the lock from a navigation and maintenance standpoint. Crosscurrents are set up where the thalweg crosses from one side of the river to the other; this action is caused by an unstable riverbed. Therefore, the thalweg will change positions frequently in some reaches each time there is a flood discharge. This condition also occurs where sizable tributaries enter the stream. Feasible site locations with necessary river training works should be included in the project plan to eliminate these flow characteristics. If locks are constructed at either the head or tail of a river crossing, or immediately below the mouth of a tributary, crosscurrents will occur at the approach channel leading to the lock. These currents, along with the prevailing winds, may force the tow off course and over the dam or force it against the bank or

the lock. If the tributary immediately above the site is a navigable waterway, and the lock's size does not permit a tow to pass in a single lockage, traffic congestion in the vicinity of the lock may cause additional difficulties. These problems may be caused by the need for extra space where broken tows can stand by and maneuver while regrouping. These undesirable characteristics that may affect the efficiency and safety of navigation should be eliminated by alternative siting or addition of river training works and protective structures. The selected alternatives should also consider what, if any, obstructive effects the lock structures will have on existing natural conditions such as the effects on the river currents. A pair of locks located on the riverside of the shoreline, on the deep side of the stream, may deflect enough streamflow from its natural course to cause appreciable crosscurrents. Engineering works should be included in the project plan to eliminate the undesirable navigational attributes. Otherwise, failure to eliminate these deficiencies during design may result in difficult navigation conditions after the project has been completed and in the need for expensive maintenance and modification after the project is placed in operation.

(3) Visibility. From the towboat pilot's standpoint, adequate visibility and ease of approach must be incorporated in the lock design. Pilots often have difficulty checking the momentum of a long and heavily loaded tow using rudder and prop control because of the inertia and relatively low power-mass ratio of the vessel. Pilots have described this problem as "like trying to balance a broom upright on your finger." To maintain control of the tow, pilots should have a clear view of the lock entrances for a sufficient distance both from the upstream and downstream directions. The distance will vary with the characteristics of each site and will depend upon the velocities of the stream and the power of the vessels, but a clear site distance upstream and downstream of one to two miles is preferable. Usually, because the tow is floating along with the current and cannot exercise full propeller steering power, the upstream approach is more difficult to navigate than the downstream approach where the tow is pushing against the current. However, these risks can be reduced by providing downbound approaches aligned with the current, with adequate sight distance, and with the downbound lock placed close to the bank for the tows to align on the approach to the lock.

(4) Lock location with respect to riverbanks and streambed.

(a) The location for a lock with respect to channel alignment, river currents, riverbanks, and damming

structures directly affects the time required for a tow to approach and transit a lock. For lock and dam construction in open rivers, the lock is usually located against one bank of the stream adjacent to the end of the dam, while in canal construction the lock often forms the damming surface to maintain pool.

(b) Since the locks located adjacent to a spillway dam in the river will block a significant amount of natural flow area, compensating flow area needs to be provided in the spillway area. This procedure will pass flood discharges without producing swellhead effects that could cause appreciably greater damage to the land and industries upstream than would have occurred without the lock. On main stem rivers, enough gated spillway area has been provided to hold the swellhead to 2 ft or less at the project location. Minimizing the swellhead effect will also reduce outdraft conditions from the lock approach into the dam at open river conditions. On the other hand, for rivers that carry a heavy silt load, too much spillway area could cause silt to build up in the lock approaches. If the tentative site does not furnish adequate width for the desired spillway area, the project will incur increased cost because of either the increase in flood damages or the lock having to be placed outside the banklines to obtain additional area. Increased excavation for foundations and approach channels needs to be compared with possible savings in cofferdam costs for constructing the locks in overbank areas. When such conditions exist or if the stream meanders with short radius curves of large central angle, it may be possible to construct a cutoff canal with a lock near the downstream end of the cutoff. This configuration may produce increased navigational efficiency rather than relying on a program for maintenance of the project depth in the natural channel. A general hydraulic river model should be used to verify the alternate lock locations. If shoaling or scour is expected, then a movable bed hydraulic model should be used to test the lock and dam configurations.

e. Nonnavigation considerations.

(1) Existing facilities. Alternative locks site studies should consider the impacts and disturbances to existing public and private installations such as bridges, utilities, and pipelines. The evaluation of these potential sites should also consider the political, social, and economic costs for modification or relocation of these facilities.

(2) Use of lock as supplemental spillway. During times of high or flood discharges, the lock structure may be used as an auxiliary controlled spillway. However, this auxiliary use functions only if the lock is designed so

that the upper gates or other closure structure can be closed under head with flowing water conditions. In this case, the lock chamber and floor should be designed for the expected scouring velocities. Miter gates are not suitable to be closed under this condition; therefore, special gates such as lift gates or emergency type closures need to be provided to make closure after the lock is opened for flow. This design should only be considered in situations where a narrow waterway at the lock site so restricts the flow that potential flood damage would greatly exceed the amount expected in open river conditions.

(3) Cofferdam considerations. Because the cost of cofferdam construction could prove expensive, careful evaluation of the cofferdam scheme and of alternatives should be made. In fact, the costs of cellular cofferdams and dewatering necessary to construct a lock and dam in stages within the river channel can amount to 20 to 30 percent of the total construction costs. Therefore, it is important to determine the optimum cofferdam scheme, sequence of construction, and number of stages during the alternative site selection process. Potential sites where locks and dam can be constructed in a cutoff outside the river channel can be more economical, if lands are available and navigation conditions are suitable. All feasible cofferdam alternatives should be evaluated for costs, construction sequence, construction schedules, effects on navigation, sediment transport, scour, and passage of flows. The evaluation should address the following alternatives: sequence of construction (locks first or dams first), number of cofferdam stages, type of cofferdam, and cofferdam heights. A risk analysis should be performed to determine the optimum cofferdam height based on probability of river stage occurrence. The probability of overtopping the cofferdam at a certain elevation (cost of structure) can be compared to the damages associated with the frequency of flooding the cofferdam (cost of damages) to provide data for the selection of top of cofferdam. For design of cofferdams on main stem rivers, a 10-year frequency is a reasonable criteria that generally meets the optimum criteria. The risk analysis procedure is outlined in ETL 1110-2-532. A three-stage cofferdam layout is shown on Plate 1.¹ Cofferdam details are shown on Plates 2 through 4 and a temporary river closure is shown on Plate 5.

f. Accessibility. The accessibility of the project site with respect to initial construction, maintenance, and operation must be considered. Adequate staging areas

¹ Plates mentioned in this chapter and succeeding chapters are included at the end of the main text.

should be provided and protected against flooding. In addition, site access under normal conditions and during flooding should be available for construction and operation. Land access should be provided to construction areas as well as to the various cofferdam stages. During the planning and estimating stages, the availability of construction materials should be determined. Facilities must be accessible for the transport of construction materials such as suitable coarse and fine aggregates, protection stones, structural and prefabricated items, and machinery and equipment. Electric power also should be available for project construction and operation.

3-4. Lock Size and Configuration

a. Size. The number, length, and width of lock chambers should be determined from the previously discussed economic and cost alternative studies. Criteria for the proposed physical dimensions for a lock must also include the requirements established by existing legislation and other official restrictions. For example, navigation depths on existing waterways are often dictated by existing laws, such as the authorized 9-ft channel on portions of the inland waterway. The plan dimensions for the new projects should be at least as large as the dimensions for other locks on that waterway, otherwise unnecessary traffic bottlenecks may occur. Larger plan dimensions should be considered, if other locks on the waterway are to be enlarged or if larger dimensions will serve to increase the navigational efficiency of the waterway. The widths of most locks in the inland waterway system will be controlled by the number of barges abreast that are in general use for that stretch of the system. Usually, the lengths of most locks will be related to the number of barges placed end-to-end that are to be accommodated in a lockage.

(1) Controlling factors. Determining the size of lock to be used in the plan of improvement involves numerous factors including type and quantity of traffic, lockage time, and waterway features. For example, the ease with which a tow of barges can be dispatched through the lock depends upon the type of barges used on the waterway, the arrangement of the tow, the inclusion of haulage units, and the prevailing type and size of the towboat in relation to the usable size of the lock chamber. Locks that are utilized above 80 percent of capacity will have queues form at heavy traffic periods with significant backup for the tows. The lock should be long enough to accommodate the standard tow using the waterway in one lockage without having to split the tow into a double lockage. In addition, the lock size should be large enough to accommodate the traffic which can reasonably be anticipated

during the life of the structure. If the waterway has features such as treacherous reaches, sharp bends, narrow channels, and shallow depths which restrict the size of tows and cannot be corrected, then lock sizes should be determined by the normal size barge tows that can navigate the restricted stretches of the waterway. The design of lockage facilities should also account for connecting waterway systems. The dimensions of a lock chamber (width and length) are determined by a balance between economy in construction and the average or probable size of tow likely to use the lock. (Chapter 5 provides more specific information about lock dimensions.)

(2) Transit time. The time required for tows to transit the locks may constitute a significant part of the total trip time for a tow. The objective is to develop an overall design that reduces transit time. The optimum transit time should be determined by economic studies to balance costs and capacity. Transit time can be separated into seven components:

- (a) Time required for a tow to move from an arrival point to the lock chamber.
- (b) Time to enter the lock chamber.
- (c) Time to close the gates.
- (d) Time to fill or empty the lock.
- (e) Time to open the gates.
- (f) Time for tow to exit from the chamber.
- (g) Time required for the tow to reach a clearance point so that another tow moving in the opposite direction can start toward the lock.

(3) Methods to reduce transit time. The seven components of time listed represent the total transit time for continuous lockages alternating in direction of movement. Two of the seven time components listed above (gate operating time and filling and emptying time) depend on design of the lock operating equipment. However, approach time, entry time, exit time, and departure time are dependent on pilot skill, towboat capability, design of the approach channels, guide walls, and lock wall appurtenances (line hooks, check posts, floating mooring bits, etc). Particular attention in the design needs to be given to laying out the upstream approach walls to reduce out-draft with flow through features to align the currents into the approach to the lock. For dual locks, transit time can be reduced by separating the locks a sufficient distance to

allow simultaneous arrivals and departures. Every minute saved in transit is significant economically, especially when locks reach capacity and queues begin to form. For intermediate lift locks, filling and emptying systems can be designed for 6 to 8 minutes (min) to fill or empty; however, filling or emptying a high-lift lock requires up to 10 min. Miter gates can be designed for operating times of 1 to 2 min. Layout of the locks, guide walls, adjacent dam, and approaches can be model tested to minimize transit times.

b. Sizes of existing locks. Historical information on lock sizes is contained in Bloor (1951). The paper not only contains valuable historical data but is also recommended reading for anyone participating in navigation lock planning and design. This reference also discusses the location, size, and date of construction of navigation locks on the inland waterways of the United States and establishes reasons for past lock size selection. In addition, this paper examines factors governing the selection of lock sizes, trends in barge and towboat sizes, and towing practices and states that lock sizes adopted in the past have frequently been too small to allow utilization for the full physical life of the structure. The most recent information on the location, size, lift, and date of construction of navigation locks on the inland waterways of the United States is contained in the IWR Report 88-R-7. In this report, an examination of the tabulation of lock sizes reveals the following trends in lock sizes:

(1) Most locks built since 1950 have chamber widths of either 84 or 110 ft with lengths varying to suit the particular waterway system.

(2) Approximately 32 locks with 56-ft-wide lock chambers and 360- to 747-ft lengths have been constructed. However, the last 56-ft-wide lock was opened in 1965. Replacement locks at the existing 56-ft-wide locks have been 84 ft wide. In the future, any 56-ft-wide locks will probably be constructed only in special situations.

(3) Other locks have been built that have widths varying from 18 to 86 ft.

(4) Locks on the Gulf Intracoastal Waterway and the Atlantic Intracoastal Waterway have been built with widths varying from 52 to 110 ft and lengths from 310 to 1206 ft.

c. Standard lock sizes. The selection for a lock size will be made from the following lock dimension table. Deviations from these lock dimensions will only be granted by HQUSACE with sufficient justification.

Lock width, ft	Lock length, ft
84	600
84	800
84	1200
110	600
110	800
110	1200

These lock dimensions are usable dimensions; these dimensions are not to be encroached upon by lock gates, sills, or other lock features. For the most common type of lock with mitering lock gates, the usable length is measured from the downstream side of the upper miter sill where it joins the lock wall to the upstream point of the lower gate when it is in the recessed position. Deviations from the above listed standard lock sizes are authorized for the following systems:

- (1) Locks in the Great Lakes-St. Lawrence River waterway system, which are 80 ft wide by 800 ft long.
- (2) Locks in the Columbia River-Snake River system, which are 86 ft wide by 675 ft long on the major portion of the waterway and either 86 by 500 ft or 86 by 360 ft on smaller streams in the system.
- (3) Locks on the Intracoastal Waterways, which have special width requirements. (The Army Corps of Engineers New Orleans District is conducting a study to determine the feasibility of standardizing lock widths at 110 ft.)
- (4) Locks to be used by small crafts, which do not require lock facilities as large as the established standards.

d. Barge and towboat size. Lock design and barge design have influenced each other to such an extent that the sizes of each generally correspond to the other. Before the lock size is determined, studies should be conducted of the prospective equipment which will use the waterway system. Data on the width, length, capacity, power, and number of barges and towboats, including the years in which they were built and operated on existing similar waterways, can be obtained from various Corps of Engineers offices and barge-line operators. These data can help to determine which group of barges and their tow formations are the prevalent configuration for the waterway system being studied. Tabulated data on barge and towboat sizes are contained in IWR Report 88-R-7 and in the ASCE paper by Bloor (1951). Figure 3-1 shows barge and towboat sizes.

e. Lift.

(1) The function of a lock is to transport vessels vertically from one level to the other whether the lock is connected to a spillway in the river, in a canal, or in a harbor. The maximum lift of a lock is defined as the vertical distance from the normal pool upstream of the lock to minimum tailwater surface downstream of the lock. Since the criteria for design of the lock structures, gates, filling and emptying systems, and operating equipment are determined by the lift, lift should be one of the first factors to be determined in the project formulation.

(2) Cost and time are two important factors that must be considered to determine lift. Currently, the trend in modernization of waterway systems is to replace several low-lift locks with one higher lift lock. Since lockages are time-consuming and expensive for waterway operators and from a waterway maintenance and operating standpoint, configuring a waterway of considerable reach with fewer higher lift locks instead of many low-head structures may improve the lockage time. Also, many low-lift locks along the waterway could limit the development and usefulness of the waterway. The overall cost for one high-lift lock is often lower than the combined cost of two low-lift locks which, together, would equal the lift of the high-lift lock; however, the design of the high-lift lock may be more complicated. The trade-off is that higher lift locks may cause more damages, involve environmental impacts, require relocations, and involve modification to flood control works along the waterway system to accommodate the higher pool levels. Since these considerations apply to new construction and to modification of existing projects, it may be important to make such decisions on a site-specific basis.

f. Single lock. Generally, a single lock on a waterway system with sufficient dimensions to handle the standard size tows without double lockage will have enough capacity to handle the 50-year tonnage capacity. In fact, a large lock may be more economical to construct and operate than two smaller locks. Providing two smaller locks of equivalent capacity may require that tows be broken and their barges be pushed through in two or more lockages, depending on how small the lock is and/or how many barges are in the tow. Obviously, breaking up tows and making up tows for lockages through small locks will cause delay and incur economic penalties for moving the tonnage through the lock.

g. Dual locks.

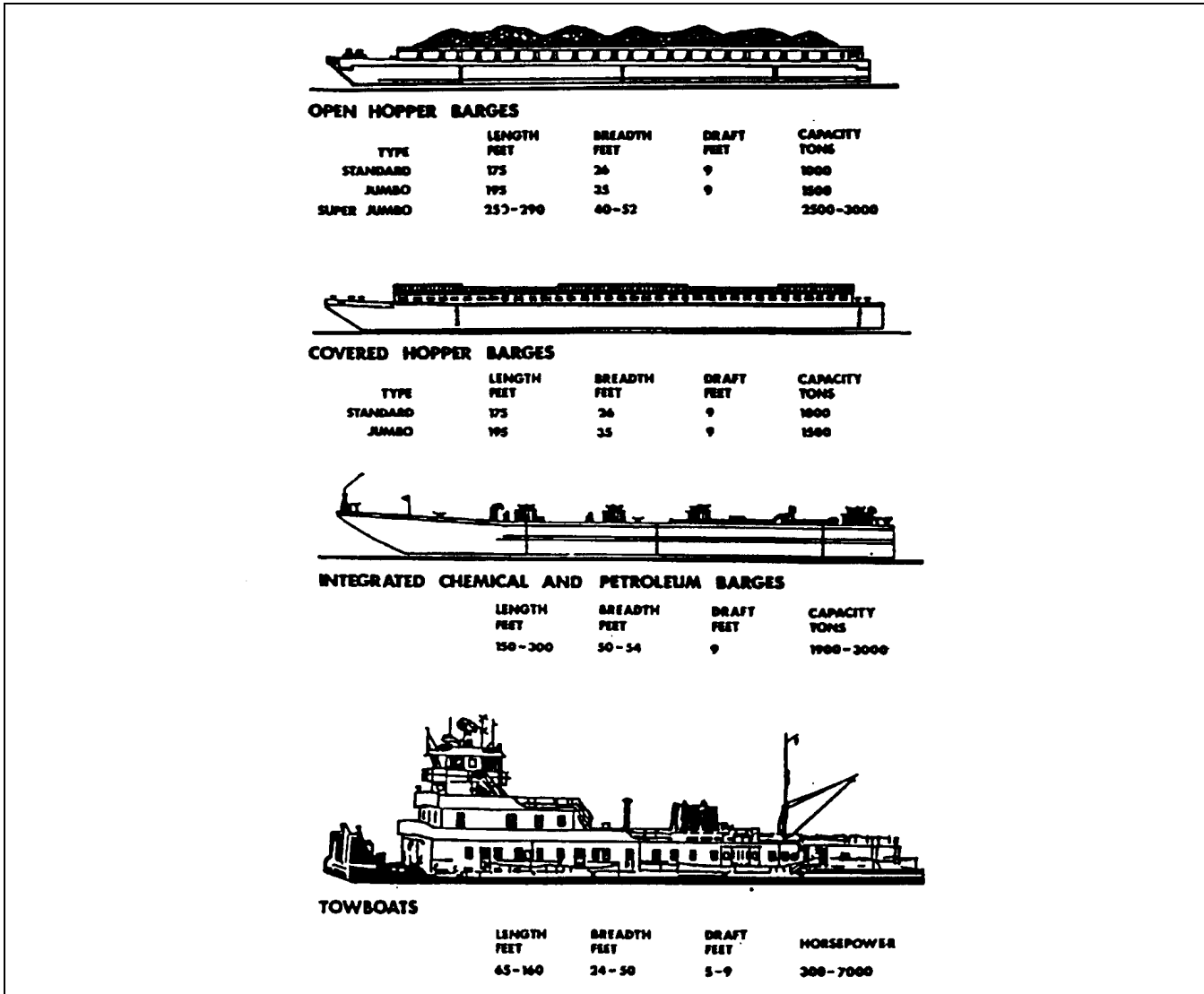

Figure 3-1. Barge and towboat dimensions

(1) On the other hand, 50-year traffic projections may require dual locks to handle the projected tonnage. If an auxiliary lock with smaller capacity (shorter length) than the main lock is provided, the auxiliary lock should have the same width as the main lock. This will allow the interchange of spare gates, emergency closures, maintenance bulkheads, and operating equipment between the two locks. In addition, the same width will handle the standard width tow configurations on the waterway but composed of fewer barges. As a further consideration, the smaller auxiliary lock can be used to handle most smaller tows and recreational craft, and the main lock can be used to handle the larger tows which should maximize the tonnage capacity of the lock project.

(2) If a navigation project is configured for dual locks of equal size, the alternatives for unseparated locks (sharing a common intermediate wall) and separated locks should be studied for operational efficiency, capacity, cost, and safety. The separated locks will allow placement of one or two spillway gates between the locks to provide flow between the locks to align navigation flows and to pass ice. Separated locks can provide improved traffic handling efficiency and greater capacity, since the tows can make simultaneous approaches and departures. The separated locks can provide for construction staging of cofferdams which could place one lock in operation at an earlier time. The disadvantages of separated locks are higher first cost and the requirement for site conditions

that will allow space in the river to site the wider structures. Nonseparated lock configurations that usually have a lower first cost may exhibit problems with crosswinds, crosscurrents, and other factors which can inhibit the simultaneous approach of tows headed in the same direction. This impairment can be improved by using approach walls of appropriate length and orientation, standby areas for tows, and various traffic control procedures (three up and three down procedures). If the site conditions warrant, then a study should be performed and reported for these alternatives.

h. Tandem locks. Tandem locks (locks or lock chambers placed in series) at a given facility will probably not be feasible for low lifts since much more time will be required for multiple lockages than for a single lockage. However, where the overall lift is extremely large (over 100 ft), tandem locks may be the feasible engineering alternative or the most economical choice. Engineering feasibility and cost studies for these alternatives should be performed to justify the installation of tandem locks.

i. Approach walls. The design of the lock approaches can have a significant impact on lock capacity, depending on the volume and bunching of traffic to be handled within a given time period. The purpose of approach walls is to align the approach currents parallel to the lock and to provide a smooth surface for the tows to land and guide on in order to make a parallel approach into the lock chamber. To achieve optimum lock approach conditions, measures must be provided such as controlling direction of current in the approach channel and providing maneuver room to allow for strong crosswinds. Without proper approach conditions, a tow, such as a string of empty barges affected by crosswinds, could take up to an hour to make a safe entrance from just a few hundred feet upstream of the lock.

3-5. Project Engineering Alternative Studies

a. Alternate studies. During the feasibility stage, alternate studies need to be performed and supplemented, if necessary, by more detailed analysis, design, verification, testing, and research and development during the feature design stage. Resources, budgets, and schedules for the alternative study plan need to be identified and included in the Project Management Plan. Examples of alternate studies may consist of the following considerations.

(1) Site selection studies. All feasible sites should be examined for addition of lock structures (or lock and dam structures). These alternative sites could consist of the

addition of a lock to an existing project with rehabilitation of the remaining structure, complete replacement of the lock and dam at an alternate site, lock located landward of the existing lock, lock placed on the opposite dam abutment from the existing lock, or any other feasible alternative. Supporting documentation should consist of engineering feasibility studies, cost studies, and economic analysis.

(2) Cofferdam and diversion alternative studies. These studies should include type of cofferdam (earth, sheet pile, etc.), number of cofferdam stages, cofferdam heights, sequence of construction (locks first or dam first), river training works, effects on navigation, river diversion, by-pass canals, scour, deposition, lands, and damages.

(3) Lock configuration studies. These studies consider feasible alternatives for lock offset, location with respect to dam, and separation.

(4) Lock structure type and geometry studies. These studies include types of emergency and maintenance closure, high-level (over both lock and dam) or low-level (over dam only) service bridges, scour protection, type of filling and emptying system (side port, bottom longitudinal), ice management features, and type of lock structure (gravity, semigravity, U-Frame, W-Frame).

(5) Alternate lock foundation studies. These studies should determine the type of foundation for the locks, which include pile founded, soil founded, rock founded, and type of piles (steel H, pipe, concrete, reinforced concrete slurry walls, and others).

(6) Innovative construction. Designers should study innovative construction methods which may reduce project costs. These innovations may include use of precast components, float-in elements, and in-the-wet construction to eliminate cofferdams.

b. Cofferdam and diversion alternatives. Usually, a lock construction site is either located in an existing waterway channel, or it is exposed to flooding because of its proximity to the channel. Therefore, the waterway must be diverted away from or around the construction site either by an auxiliary waterway passage or through use of a cofferdam or by combining the two methods. The two principal considerations then are the method of diversion and the degree of protection against unplanned flooding of the site. Ideally, the chosen diversion method will be the most economical one that will satisfy the necessary engineering, environmental, and social considerations. The principal reference for cofferdam and

diversion planning is ER 1110-2-8152. This reference attempts to address all of the concerns of the various disciplines and entities which have an interest in the cofferdam and diversion requirements. Also, this regulation has been supplemented by subordinate commanders to accommodate requirements unique to work in their divisions and/or districts.

(1) Diversion methods.

(a) Lock construction outside the waterway channel. Lock construction in a bendway out of the waterway channel is preferred over most other types of construction sites, particularly if the site under consideration is not in urban or environmentally sensitive areas. Since this type of site is not within the channel, diversion during construction is not required. With this site, the cofferdam requirements are basically those needed to protect the lock construction site from flooding when the waterway stages are above top bank. For lock construction outside of a waterway channel, a top bank site outside the channel is normally preferred. This preference applies particularly to locks on waterways that are made navigable for the first time and also applies to many replacement locks.

(b) Lock construction within the waterway channel. Despite the preference for lock construction outside the channel, conditions may dictate that the lock be constructed within the permanent waterway channel. For example, when the lock under construction is replacing an existing lock, when channel realignment is not feasible, or when relocation costs associated with alternative construction sites are prohibitive, then the channel site may become the recommended site. For this type of site, a cofferdam is required to protect the construction work through a wide range of possible waterway stages.

(c) Temporary flow and navigation diversion. In many instances, flow and navigation during construction can be handled within the existing channel. In the case where lock construction takes place within a cofferdam(s) located in the channel section, staged construction may be required. Staged construction does not restrict flow to such extent as to induce flooding upstream of the construction site or to create significant swellhead at the construction site; thus, it will maintain existing navigation on the lock. For example, in the case of Melvin Price Locks and Dam, a major portion of the dam was built in an early stage of construction so that the dam could be used to divert a portion of the Mississippi River flow during lock construction. Conceivably, a variation of the above-mentioned diversion schemes would be a temporary rerouting of flow (or portion of the flow) through another

existing waterway or through a new channel excavated for the purpose of diverting flow. This scheme would allow the new lock to be generally oriented in the existing channel alignment and reduce the possible incidents of tow damage to the cofferdam that is constructed in the existing navigation channel.

(2) Cofferdam designs. Generally, if the lock can be built outside the waterway channel where a cofferdam of earthfill construction can be used, this type of design will achieve the greatest economy. Also, this location usually allows more of the lock construction work to be done in the dry and at a greater degree of economy than if at a location where a sheet-piling cell cofferdam is required. With a cellular cofferdam, phased construction may be used advantageously. In phased construction (see Plate 1), plans should be made to reuse sheet piling when the cells are to be relocated between phases and/or when the sheet piling can be used in other applications such as for approach wall support piers. Principles for cofferdam layout and design are included in ER 1110-2-8152 and EM 1110-2-2503.

3-6. Engineering Considerations

a. Hydrologic and hydraulic studies. To perform the structural layout and design of the navigation lock, hydrologic, hydraulic, and potomology data are needed to determine the hydraulic dimensions, elevations, scour protection, and river training works. Before the types and sizes of structures can be determined, detailed hydrologic and hydraulic data must be obtained. This information includes the following: records of maximum, minimum discharge volumes, stages, velocities, and continuous stage hydrographs; stage duration and stage frequency relationships; pool and tailwater stages, and pool regulation procedures; precipitation and runoff; and temperature and ice conditions. In addition, potomology information for scour, deposition, bed load, silt carrying characteristics, and water quality is needed. Other hydraulic information on surrounding infrastructure should encompass such details as banklines, railroad and highway profiles, bridge heights, sewer outlets, water intakes, and river regulating works. This information should be compiled in a usable manner through drawings, charts, and graphs by hydraulic engineers for use of the project team to determine the top of lock walls, sill, and chamber depths. The methods used to procure and process such information for hydrologic analysis are contained in the EM 1110-2-1400 series; the methods for hydraulic analysis are contained in the EM 1110-2-1600 series. Information for the hydraulic layout and design of navigation locks is contained in a

U.S. Army Engineer Waterways Experiment Station (WES) paper by Davis (1989).

b. Model studies. Physical model studies of the hydraulic and/or navigational characteristics of channels and dams, lock approaches, and lock filling and emptying systems are a traditional and necessary part of the planning and design for most navigation facilities. As more experience is gained and more accurate techniques are developed, mathematical models may be used more extensively than physical models in the future since mathematical model results are likely to be more economical and more quickly determined. Model studies are usually conducted in the planning and feasibility phases of project design. These studies should continue, if necessary, through the design phases to test design and construction alternatives. To limit the scope of model testing, the plan should use the model testing information covered in numerous WES publications and in design memoranda for many existing navigation projects to develop approximate project layouts and structure configurations. In addition to the more traditional model tests, model testing may need to be done for sediment transport in the channel and through the lock and for scour testing. Model testing is particularly important if the lock is to be constructed in a river that has a history of transporting large volumes of sediment and/or if the riverbanks have not been stabilized by revetment and other forms of canalization. Dredging requirements can be extensive and costly if the channel bed is not stable or if sediment transport cannot be managed by rock dikes and other types of channel structures. The cost of model studies varies depending on the area under study, characteristics of the streams, nature of the problem, and number of plans and alternate plans to be tested before an acceptable solution is developed. The cost of model studies has usually been less than 0.10 percent of the project cost.

c. Subsurface investigations.

(1) Comprehensive geological studies of the area should be conducted, and these studies should address the topography and geology of the area, the location and description of sites, the foundation conditions, and the foundation and seepage problems and their proposed treatment. As a part of these studies, geologic maps should be prepared to help uncover any subsurface conditions that may render a site unsuitable for a lock or any subsurface conditions that may require special considerations. EM 1110-1-1804 outlines the methods of exploration, their limitations, and the general procedure for subsurface investigations.

(2) Geophysical methods of subsurface exploration are a useful tool in the study of subsurface conditions. When applied properly with a full understanding of the limitations, such methods can be used to obtain accurate and reliable information for use in preliminary or reconnaissance studies. Detailed instructions, methods, and references are included in EM 1110-1-1802.

(3) In the planning and design of navigation locks, a geotechnical investigation is an essential step. A detailed discussion of investigation phases, exploratory methods, laboratory procedure, presentation of data, and similar requirements relating to geotechnical design is presented in the EM 1110-2-1900 series.

d. Foundation considerations. Before a project site is selected, the characteristics of the foundation materials should be studied at the possible lock locations. Usually, during the early stages of an investigation, the information should indicate the feasibility of project construction using ordinary design standards. After several possible sites are selected, the choice can be narrowed further through a foundation and navigation study. These studies should be followed by investigations of each remaining location to determine the final site.

e. Sediment transport. Most locks should be equipped with recesses to trap sediment; these recesses will prevent sediment accumulation from interfering with gate operations. In addition, the volume and distribution of sediment that may move through each waterway should be determined. If the waterway is rich in sediment, a number of permanent measures may be required to keep the sediment moving through the lock. These measures will prevent the necessity for frequent sediment removal by dredge or dragline. Usually, these measures will involve various procedures which make use of water jetting and air bubbler systems to dislodge and move the sediment. Experience gained from the Red River navigation project has shown that the channel cross section at the lock should be approximately the same as that of the natural river to facilitate sediment transport. Lock approaches in canals connected to rivers may have difficult sediment problems if a dam is not placed adjacent to the lock to assist in sediment transport.

f. Future expansion provision. Future expansion is usually limited to construction of an adjacent (or dual) lock. If studies indicate that traffic will increase sufficiently to warrant expanding locking capacity, a study should be conducted to determine if the "expanded" capacity can be justified in the initial construction. This

EM 1110-2-2602
30 Sep 95

study is necessary because the second lock will be less costly in the initial construction phase than at a later date. However, if only one lock will be constructed initially and if provisions for future construction are desired, the feasibility of such expansion should be verified within the

framework of hydraulic and navigation model studies for the initial lock. Structural features which are subject to a high rate of deterioration, such as steel lock gates, are not normally included in the minimum provisions for future expansion.

Chapter 4

Description of Locks and General Terms

4-1. General

This chapter introduces types of locks and common design terms that are used in a navigation lock project. The types of locks presented in this chapter are composed of mass concrete, reinforced concrete, tied-back concrete, steel sheet piling, and earth (chamber walls) construction. Other less common types of locks such as articulated frame have been constructed but are not discussed in this manual. The lock components introduced in this chapter include lock chamber monoliths, upper and lower gate bay monoliths, culvert valve monoliths, culvert intake and discharge monoliths, approach walls, lock sills, and lock floors. Chapter 5 provides details on the design and layout of these components. The major components of a lock are designated on Plates 6 and 7; the terms indicated on these plates will be used throughout this manual. An isometric presentation of a single lock adjacent to a gated spillway is shown on Plate 8. This chapter also includes plates which contain typical details and data that will assist in preliminary proportioning of lock structures. Most locks in the United States are made of concrete. The resistance of concrete to impact, abrasion, and deterioration and its relatively low cost to construct and maintain are the qualities which make this material the most suitable for long-life navigation structures. Depictions of projects with various size, configuration, and number of locks are shown on Plates 9 through 14.

4-2. Mass Concrete

The mass-concrete-type lock, as the name implies, is composed of monolithic wall sections which resist applied loadings by their weight and have floors of either the in-situ bedrock, concrete paving, and/or concrete struts. Size and shape of sections should be selected to fit the particular purpose and loading condition. Base widths are made sufficient to prevent sliding and overstressing foundation materials or foundation piles and to ensure that the resultant remains within prescribed areas. Top and intermediate widths are sized to provide a section which will withstand internal wall stresses and at the same time provide space for such installations as filling and emptying systems, anchorages for movable structures, operating equipment, temporary closure structures, the mechanisms, and miscellaneous accessories.

a. Gravity walls. Gravity walls are sized to resist applied loads by weight (see Plates 15 and 16). These

walls are usually considered the most economical type of structure from design, construction, and maintenance standpoints, if no unusual foundation problems exist. The supporting media can be soil, bedrock, or pile, with the resulting design being straightforward regardless of the type of foundation. The thick sections of the lock walls lend themselves to watertight construction with low maintenance cost. Construction costs are usually less than for other types of construction due to the simplicity of construction details. As a result of this simplicity, a relatively small amount of skilled labor is required for concrete placement. Other advantages of mass concrete walls are resistance to impact and abrasion of moving barges and ease of maintenance or replacement of damaged sections due to such causes. The disadvantages of these structures are few other than that loads may be heavy in relation to the supporting capacity of the foundation material and possible unequal settlement of adjacent or opposite monoliths may result in damage to or misalignment of the movable structures and the operating machinery.

b. Semigravity walls. Semigravity walls are similar to gravity walls. However, semigravity walls are designed to resist minor tensile forces at horizontal sections and are lightly reinforced. The advantages and disadvantages of these structures are essentially the same as those described for gravity walls.

c. Lock floors. The floors in mass concrete locks are not usually constructed integrally with the walls and are not used as structural members to resist flexural forces. When walls are founded on sound bedrock, the lock chamber floor can usually be excavated to competent rock without any additional treatment. However, if the foundation material is erodible, a paving slab with adequate drainage details to relieve uplift may be required. When individual mass concrete wall monoliths cannot resist lateral forces to obtain the required sliding resistance for lock wall stability, reinforced concrete struts may be added to transfer the lateral load to the opposing wall. The struts may be either continuous for the entire lock chamber length or intermittently spaced to suit the specific project requirements.

4-3. Reinforced Concrete Lock Structure

This term refers to locks that must contain steel reinforcement. The concrete members are flexural members, and reinforcing must be provided to resist tensile stresses. There are numerous instances where certain elements of a lock are made of reinforced concrete. Gravity walls are reinforced at certain thin areas, and the U-frame and

W-frame, as well as cantilevered and counterforted types, are reinforced concrete locks. Approach walls, abutments, areas around culverts, culvert valve recesses, filling and emptying laterals and longitudinals, and numerous other minor parts of most modern gravity locks are constructed of reinforced concrete.

a. U-frame or W-frame. Terms such as “dry dock reinforced concrete” and “bathtub” type have also been used to describe this type lock wall system. This type structure consists of two walls joined by a floor slab to approximate the letter “U.” The W-frame is a variation of the U-frame in that it is two U-frame locks set side-by-side approximating the shape of the letter “W.” In this manual, the term U-frame will refer to both U-frame and W-frame structures. Details of a U-frame lock are shown on Plate 17.

(1) In a U-frame lock, the walls and floors are designed to act together as a frame and thus are heavily reinforced. Therefore, at high-stress areas No. 14 and No. 18 reinforcing bars are not unusual. Since an intimate knowledge of the foundation properties is required, it is essential that geotechnical and structural engineers maintain close communications throughout the design process. The U-frame may also be founded on rock or steel “H” piling in addition to soil. The advantages of this type lock are lower, more uniform foundation loads, permitting construction on relatively weaker foundations; rigidity against differential settlement or wall rotation; and the capability to unwater the lock chamber for inspection and repair without special foundation treatment for unwatering. The disadvantages of this type of structure may include higher design and construction costs and restricted types of filling and emptying systems.

(2) Advantages of using the W-frame as compared to using two adjacent U-frames include the following:

(a) Lower construction cost through elimination of the joint between the two middle walls.

(b) More efficient resistance to uplift forces since the base is continuous.

(c) Greater potential to use common components for filling and emptying.

Disadvantages of the W-frame lock are a greater concern with thermal effects from continuous concrete placement for the large lock base area and limited experience with construction of this type of lock.

b. Cantilevered or counterforted (buttressed) lock wall. This lock type is one with reinforced concrete retaining walls. Its use should generally be limited to the chamber walls between gate monoliths and to approach walls. The walls may be either cantilevered or counterforted. Spread footings, forming a portion of the lock floor, satisfy the conditions for stability with the keyways preventing sliding and acting as cutoff walls, while at the same time reducing the uplift pressures. The cantilever lock wall dimensions are determined by the size of the filling and emptying system culvert, the pipe gallery, valve and gate recesses, etc., and also must be thick enough to be compatible with the reinforcing steel required. An advantage of this type of construction is that fairly high walls can be provided at a lock location where the foundation properties are poor. There is only one installation of this kind in the United States on a major waterway, e.i., a buttressed wall-type lock named “Little Goose” on the Snake River.

4-4. Tied-Back Concrete

The tied-back concrete wall consists of a reinforced concrete wall which is tied back to a competent material. Ties can be steel reinforcement, prestressing threaded bars, or stranded tendons. The reinforced concrete walls are thinner than other wall types but must be thick enough to contain culverts, galleries, and appurtenances such as floating mooring bits, check posts, and ladders. Tied-back concrete walls are suitable for use as lock chamber walls and approach walls only and are not adaptable for gate bay monoliths. The project site must have competent material present at the proper elevation for anchoring the tieback. Alternate tiebacks include dead-man-type anchors and battered pile anchors. Details of tied-back concrete walls are shown on Plate 18. Although the tied-back wall design is feasible and savings are possible, attention should be focused on the following issues: provision of corrosion protection for the tendons; preparation of rock surfaces to which the wall is to be anchored; careful alignment of holes in which the tendons are to be anchored; provisions for monitoring the retained stress in the tendons by use of pressure cells; and provisions for restressing the tendons in case of a stress loss. The main advantages of this type wall are the significant cost savings from less rock excavation, less concrete, and a shorter construction time required. The disadvantages include: the requirement for the contractor to excavate to the neat lines shown on the drawings; the difficulty in maintaining the relatively precise alignment of the holes in rock for encasing and anchoring the tendons; the difficulty of providing corrosion protection with the required

high degree of confidence; and the necessity to monitor the stress retention in the tendons throughout the life of the structure.

4-5. Steel Sheet Piling

Steel sheet pile lock walls are used only for lock chamber walls and upper and lower approach walls. This type wall is usually used at locations where traffic is not heavy or where a temporary lock is needed. Two basic types of sheet pile walls have been used including anchored tied-back wall and granular filled cellular structures. The first type of wall consists of "Z" piles or arch piles, and the second type consists of straight steel sheet piling. Gate bay monoliths and valve monoliths are usually concrete structures supported on soil or on steel bearing or friction piles. These piling-type walls have been generally used for lifts up to about 15 ft. Sheet pile locks are filled and emptied through sector gates, loop culverts, a combination of sector gates and culverts, valves in miter gates, or special flumes. Details of a sheet pile lock are shown on Plate 19.

a. Anchored and cantilevered (tied-back). Where anchored pile walls are used, a Z-type pile section is often employed for this type of construction because of its high section modulus and interlocking properties. These walls may be provided with a horizontal waler, and tie rods with turnbuckles and dead-man anchorages. Concrete struts may be provided across the floor of the lock chamber to take the reaction of the walls and prevent their inward movement as well as the movement of the lock floor material from around the steel piling. The lock chamber face can be provided with horizontal fenders of timber or steel at levels where tows usually rub. The offsets formed by the Z-piles provide spaces for recessed mooring hooks and ladders. Special anchorages at the top of the lock walls can be provided for check posts to facilitate tying up barges during locking operations. One type of wall consists of piling driven into the foundation material, where stability is gained entirely by passive resistance of the soil below the stabilized groundline. This type of construction is used for retaining walls and is seldom employed where the height of the fill to be retained is in excess of 10 to 15 ft. The other type of construction provides one or more intermediate supports attached to buried anchors in the backfill, with the bottom of the wall restricted by passive resistance. A variation of the latter method for lock walls introduces a system of beams and struts at the floor level. Plate 7 illustrates lock chamber walls of "Z" piling with intermediate supports and lock floor strut systems. EM 1110-2-2906 describes

a wall using intermediate tied-back supports and passive resistance from the bottom support.

b. Cellular. Another type pile wall uses steel sheet piling driven to form cells. These cellular walls are filled with sand and gravel and are, in effect, gravity-type retaining walls. Ripping, tearing, or wearing down of the pile interlocks of the cell by barge contact is a concern with cellular structures. Thick steel plates welded onto the cells or onto reinforced concrete panels on the chamber side help to prevent this type of damage. Locks of this type are generally considered temporary with a projected service life of 15 to 20 years. However, O'Brien Lock on the Illinois Waterway was designed as a permanent structure and is in existence today. Layout and details of cellular locks are shown on Plate 20. In the layout, note the additional line of smaller steel sheet pile cells on one side of the lock chamber which form the filling and emptying flume. The culvert valves are located in the concrete gate bay monoliths. Detailed design of cellular sheet pile structure is contained in EM 1110-2-2503.

c. Corrosion. Corrosion is a consideration for steel sheet pile lock walls because some chemical properties of the water or of the soil adjacent to the piling may either promote or accelerate corrosion. The piling and other components are usually used without coatings or cathodic protection of any kind. However, investigation should be made at each individual project to determine the advisability of providing protective coating or cathodic protection. It has been judged in the past that the material loss due to corrosion during the life of the structure will not be detrimental to structural functioning of the piling. It has been observed on existing projects that the worst corrosion occurs at the waterline where constant wetting and drying takes place because of wave action. A protective coating for this area may be advisable.

4-6. Earth Chamber

In a few tidal locks on the intracoastal waterways, earth levees have been used as lock chamber walls with concrete gate bay monoliths. This type of lock is used in low-lift areas. Riprap protection is provided on the levee slopes and on the floor of the lock chamber to prevent scour by towboat propeller action. A continuous timber wall is provided on both sides of the lock chamber. These walls are made up of a series of vertical and battered (braced) wood piling surmounted by a wood walkway and faced with timber walers. Details of this type lock are shown on Plates 13 and 14. Another earth

chamber type that may be used for low-lift projects is one which uses a combination of walls and levees for part of the wall height of the portion between gate bays. These walls of concrete or steel sheet piling should be constructed to a height which can accommodate navigation for a high percentage of the time, while the gate bays, gates, and levees are built above the water stages for which lockages are to be provided. When the walls between bays are overtopped, the levees maintain the pool levels along with the gate bays. In this manner, operation can be continued for all stages for which lockages are desired. For this type of construction, wing walls or diaphragms of steel sheet piling filled with earth should be employed on each side of the lock adjacent to both the upper and lower gate bays. Plate 7 shows this type of construction.

4-7. Lock Components

The longitudinal elements of a lock are the chamber walls and their extensions upstream and downstream. Subdivisions of these walls are defined by their position or purpose in the structure as lock chamber walls, upper gate bay walls, lower gate bay walls, culvert intake and discharge walls, upper approach walls, lower approach walls, as well as guard and/or return walls. These subdivisions are further divided into types of monoliths. In the case of a mass concrete lock, the opposing wall segments are normally referred to as separate monoliths, while a U-frame or W-frame monolith will contain both opposing walls and floor (these components are constructed integrally with each other). Lock sills are located across the bottom of each end of the lock chamber to complete closure when the gates are closed. The sills usually extend upward above the lock floor by several feet and are usually designed to withstand the full hydraulic head that would occur when the lock chamber is unwatered.

a. Lock chamber monoliths. The lock chamber monoliths enclose the lock between the upper and lower gate bays. An intermediate wall for the lock chamber is required for dual, side-by-side lock construction or where provision is made for the installation of a second lock at a later date. The chamber monoliths are usually of uniform cross section.

b. Upper and lower gate bay monoliths. The gate bay monoliths include those portions of the lock which house the gate recesses, gate anchorages, gate machinery, and sometimes culvert valves and culvert bulkheads. Plates 6 and 17 show these elements of a lock, as well as the following elements.

c. Bulkhead monoliths. Bulkheads should be provided to unwater the lock chamber or individual gate bays. Bulkhead slots can be placed either in the gate monoliths or in separate monoliths.

d. Culvert-intake and discharge monoliths. Intake monoliths extend immediately upstream beyond the upper gate bays. They provide space for intake ports which lead to the culverts. Discharge monoliths are frequently located immediately downstream of the lower gate bay monoliths and extend far enough to allow the emptying culverts to exit the lock walls.

e. Approach walls. The hydraulic characteristics of the waterway in the vicinity of the upstream and downstream lock approaches and the nature of the traffic dictate what type of special structures are needed to facilitate entrance to and exit from locks and reduce hazards caused by adverse currents. Plates 21 and 22 show various layouts for approach walls. Tows large enough to nearly fill the width of a lock chamber must carefully approach the lock. During adverse current or wind conditions, an approach wall offers a wide, safe target as the operator initiates alignment for entry into the lock. The wall also helps the operator to check the progress of a tow by using check posts or line hooks to correct the alignment. Approach walls also provide mooring spaces for the separated part of tows which are too long to negotiate the lock in one lockage. Thus, approach walls contribute to the safety and speed of lockage. A depiction of various approach wall designs is shown on Plates 23 through 29.

(1) Guide walls. The term guide walls refers to the long extensions of the lock walls, in either the upstream or downstream direction, that are parallel to the lock wall. These walls serve primarily to guide the long tows into the lock and to provide mooring facilities for tows too long to be accommodated in a single lockage. Guide walls can be placed on either the landside, riverside, or both sides of the lock approach, depending upon channel conditions.

(2) Guard walls. Guard walls (see Plate 27) are approach walls designed to minimize entrance or exit difficulties caused by currents. Guard walls also act as barriers to vessel movement in the direction of navigations hazards and serve as the final means of directing the front end of the tow if it is not properly aligned in the direction of the chamber. This measure will help avoid head-on impact with the end of the lock wall. These walls are generally shorter walls that flare away from the

lock approach; however, guide walls that perform these functions can be termed guard walls.

f. Miscellaneous structures.

(1) Return walls. Return walls are retaining walls used to retain the landside lock backfill at the entrance and exit of a lock. Return walls offer several advantages in that they can provide a small docking area out of the lane of traffic at the entrance to the lock and larger operational area near the lock gate area. However, these walls do add significantly to the cost of the project. A typical lock layout with return walls is shown on Plate 8.

(2) Bank tie-in walls. Bank tie-in walls are used to tie the lock structure to higher ground and also serve as a dam to retain the upper pool. These walls may be of a variety of types such as gravity, sheet pile cells, buttresses, inverted tee, etc. The most common type in use today is the inverted tee cutoff wall which is shown on Plate 8.

(3) Separation between locks and dams. If the lock structure and dam are separated, a damming surface must be provided between the two structures.

g. Lock sills. Lock sills are those elements of a lock forming the fixed portion of the damming surface under the service gates or temporary closures. Service gate sills differ from temporary closure sills in that they are used for each lockage, while the latter are in use only when the lock is unwatered for maintenance or during an emergency. The elevation of sill tops in relation to the water surfaces of the upper and lower pools dictates the draft of vessels which can use the lock.

h. Lock floors. The lock floor can be paved, strutted, or left as the natural foundation material as discussed previously in paragraph 4-2c.

Chapter 5 Layout and Design

5-1. General

This chapter provides guidance for the layout and design of navigation locks. Guidance and details are provided on the following features: lock dimensions, filling and emptying systems, lock walls, approach walls, miscellaneous walls, gate types and locations, lock operating systems, lock sills, lock wall operating requirements, lock closure, galleries and cable trenches, lock wall accessories, tow haulage unit and movable keel, and ice and debris control.

5-2. Lock Dimensions

The overall layout of a lock and the dimensions of the lock chamber are determined by making a thorough study of all controlling factors (see paragraph 3-3) before a final decision is made. The determination of elevations for the top of all lock walls, elevations for service and closure gate sills, and the elevation for the floor of the lock chamber is extremely important, since sufficient clearances are required for efficient and economical construction and operational conditions to accommodate present and future situations.

a. Width and length. Adoption of specific barge sizes by the towing industry operators over the past years has led to the standardization of lock chamber widths at either 84 or 110 ft for most new projects, unless some overriding factors exist. The standard widths and lengths for locks are discussed in more detail in paragraph 3-3c. The layout of the usable width and length of a lock chamber is governed primarily by the width of barges and the length of tows, both existing and envisioned. Usually, an additional allowance of 3 to 5 ft is added to the assembled barge widths to enable tows to enter the lock chamber without damaging the barges and to avoid undue scraping on the walls. These allowances are reflected in the most commonly used lock widths of 56, 84, and 110 ft which were established to accommodate the tow widths composed of two or more of the common barge widths of 26, 35, and 48 ft. An allowance of 30 to 50 ft in length is also made to ensure that tows entering the chamber will not damage the service gates. This allowance, plus a tow length of 1,170 ft (six 195-ft barges), and space for a miter gate recess results in distance of 1,275 ft between pintles for a nominal 1,200-ft lock. The usable length is measured from the downstream side of the upper miter sill to the upstream point of the lower

gate when it is in the recessed position. No lock feature should impinge on this space since it is for the exclusive use of waterway traffic.

b. Wall elevation. The top elevation for lock walls depends upon the characteristics of the waterway and the type of dam selected, as well as the type of lock structure. Also, to be considered are such factors as the balance between initial construction and maintenance cost and uninterrupted transportation during high stages, and other conditions peculiar to any given location.

(1) Nonnavigable dams. On important waterways with nonnavigable dams, locks should be designed so that they will be usable at all times except during large floods. The lock walls should be at least 7 ft above normal pool to properly guide high-riding empty barges along walls and thus prevent items atop the walls from being subjected to damage by an overhanging barge. The tops of the walls should be at least 2 ft above the maximum pool at which navigation is to be maintained. For important waterways where currents, floating debris, or other navigation hazards do not force suspension of river commerce at high stages, serious consideration should be given to providing lock walls of sufficient height to accommodate traffic in all but the most infrequent floods. Unless the walls are extended above high stages, the operation equipment for the movable structures will be submerged, or it will be necessary to remove the parts that are subject to water and debris damage each time the walls are likely to be overtopped. In addition to the cost and inconvenience of removing such equipment, a major cleanup job must be completed after the water has subsided, and there is always the chance of making the change too soon or too late, resulting in navigation delays or damage to machinery. It is usually wise to extend the lock walls above all stages that the economics of the project will allow.

(2) Navigable pass dams. When the characteristics of the river are such that a navigable pass dam can be incorporated, considerable savings in the initial cost of construction can be realized by using low lock walls with an operating system suitable for frequent lock submergence. Freeboard between the top of the lock wall and cessation of navigation through the lock should be 2 ft as previously discussed. In order to take advantage of this type of construction, the river must be navigable for considerable periods without the use of controlled pools, and the time intervals available for changeover from open river to controlled pool navigation or vice versa must be sufficient to allow for raising or lowering the dam. Planning of navigable dams is discussed in EM 1110-2-1605.

c. Lock sills. Lock sills are those elements of a lock forming the fixed portion of the damming surface under the service gates or temporary closures. The elevation of sill tops in relation to the water surfaces of the upper and lower pools dictates the draft of vessels which can use the lock. The effective depth of the lock (SD) is measured from the top of the sill to the water surface of the respective pool to which it connects as shown in Figure 5-1. This measurement allows for the "squat" which always occurs when a tow occupying a large proportion of the lock chamber cross section passes over a sill, even at very low speeds. Additional depth over the lower sill should be considered if there is any probability that the tailwater will have to be lowered because of changed downstream conditions. EM 1110-2-1604 provides specific guidance on sill depth.

(1) Elevation. Experience and research data indicate that the gate sill depths should be as great as practical to lessen tow entry and exit times and to lessen chamber surges during these maneuvers. A 2- or 3-ft-high gate sill (above chamber floor) or a local recess will provide space for the gate operation to clear debris. The lock floor areas immediately upstream and downstream of the gate sill should be paved so that maintenance crews and equipment can be readily accommodated during lock unwatering activities. For a lock with a gated navigable dam, determining the upper lock gate sill elevation requires simultaneous study of the navigable pass sill. The lock sill level must allow passage of tows during the time of change over from open river navigation to controlled pool operation. Therefore, the upper gate sill elevation should be slightly lower than the accompanying navigable pass sill level. If site conditions warrant, it may be advantageous to provide the same sill elevation upstream and downstream, since this arrangement permits the miter gates to be interchanged.

(2) Gate sills. In some cases, the sill is required to resist a portion of the gate load; however, this requirement is restricted to vertically framed miter gates, to wide tainter gates which have intermediate trunnion supports, and to rolling gates. All sills must resist the forces which consist of both earth and hydrostatic pressure extending from the bottom of the gates to the sill foundation. For U-frame locks, where the walls and sill are of integral construction, the sill is proportioned to distribute the wall lateral pressures. In some cases, the gate sill concrete can be used to form intake ports for culvert filling and emptying systems. Crossover galleries, containing the various utilities for the lock, are frequently included in the gate sill.

d. Lock floor. Depth in a lock chamber is governed by the depth of the sills and by requirements for the filling system cushion depth. For operation and maintenance purposes, the lock floor should have a recess for the operating gate to clear debris or be 2 or 3 ft lower than the lock sill. Figure 5-1 indicates the sill-floor relationship. The design must allow for proper clearance for any gate stops that are provided below the body of the gate. The chamber depth must be great enough to satisfy filling system design submergence requirements. The multiport system layout requires trenches in the floor adjacent to the lock walls. EM 1110-2-1604 provides specific guidance on this topic.

(1) Paved lock floor. The need for a concrete lock floor is determined by the type of natural foundation involved and its resistance to soil-carrying seepage. Paved lock floors are usually subjected to downward pressures when the water in the lock is at an upper pool elevation and to upward pressures when the water is at lower pool elevation or during the unwatered period. The downward pressures cause no difficulty; but unless pressure-relief devices are installed, the floor must be designed to withstand uplift which is caused by the difference between saturation levels in the soil and the water level in the lock. This problem can be solved by using concrete block paving placed on a sand and gravel filter directly on the natural formation. The concrete blocks should be provided with weep holes and should be separated from each other by open joints. These blocks should not be integral with the lock walls. If anticipated drainage conditions warrant the expenditure, parallel trenches filled with filter stone, open-end tile pipe, or perforated drainpipe extending the length of the lock chamber and discharging below the lower sill can be used. Filter drains are subject to clogging by fine-grained material. However, if a properly graded filter material is used, and if the river water is not silt laden, it is unlikely that the outlets will become inoperative.

(2) Other methods of lock-floor construction. To avoid thick concrete sections these methods include piles designed to resist tension, rock anchors, reinforced concrete floors, or paving on a sufficient depth of graded gravel and sand. Where sliding resistance is poor, reinforced concrete struts can be used to prevent horizontal movement of lock walls caused by lateral pressures. The monolith joints of the opposing walls should be at the same location so that the struts abut each opposing monolith. Provisions for short second placement concrete are usually made at each strut to compensate for shrinkage and thereby assure intimate strut contact to each wall. In

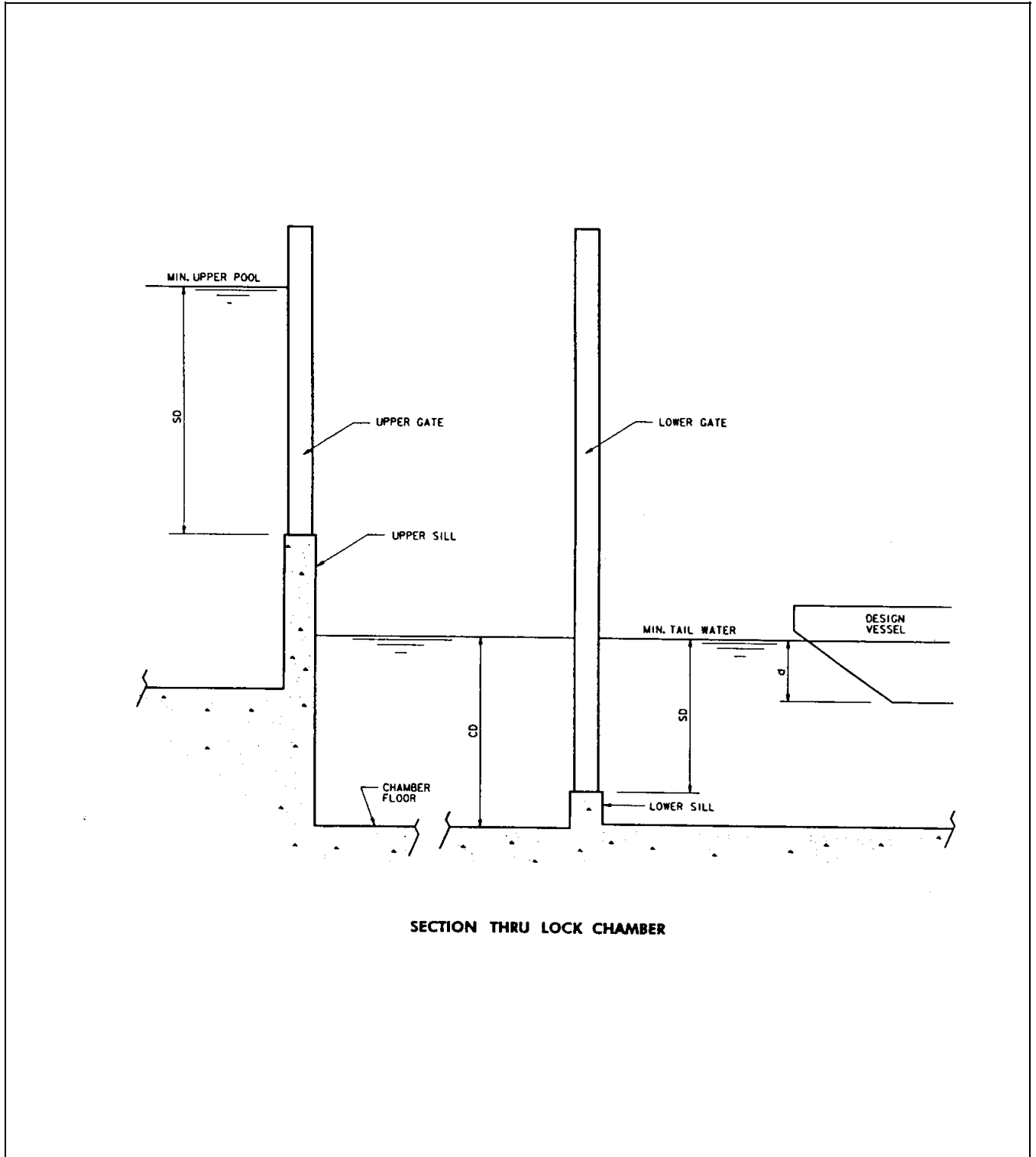

Figure 5-1. Definition sketch for lock sills

addition to being designed to resist the unbalanced horizontal force, the struts can also be designed with anchors or piling to resist uplift pressures especially during lock unwatering and other applicable stability design cases. Layout of the struts should be coordinated with the filling and emptying system layout in the lock chamber, particularly in instances of use of the bottom longitudinal and bottom lateral system. The joints in the continuous strut floor system must be water-stopped or other provisions made to take care of seepage. Struts are also provided between sheet pile walls where the foundation does not have sufficient passive resistance.

e. Approach wall. The top elevation of the upstream approach wall and upstream guard wall should be identical to the top elevation of the upper gate bay walls, even when the lock chamber walls are lower than the upper gate bay walls. Setting these upper walls at this elevation enables navigation traffic vessels to tie up to the wall at all times and offers additional safety by ensuring that the wall is visible at all reservoir pool levels. Also, the flow of water over the wall might have some undesirable consequences. The top elevation of the lower approach wall and lower guard wall should be set at least 2 ft above the maximum lower pool level or at the same elevation as the lock chamber walls if the project is subject to overtopping by flood waters. More information on these walls is contained in paragraph 5-5. Plates 21 through 26 depict typical layouts for approach walls.

5-3. Filling and Emptying Systems

When designing a lock, one of the first issues to consider is the type filling and emptying system to be used and the filling system cushion depth. The types of service gates, sills, walls, floors, and approaches often hinge on this decision. The filling and emptying system types that have been used in the lock chamber for previous lock projects include wall ports, laterals, bottom longitudinals, and multiple wall ports. Examples of these various types of filling and emptying systems are shown on Plates 30 through 33. Filling and emptying has been accomplished on some very low lifts by use of the following: sector gates, shutters in lock gates, and longitudinal flumes adjacent to the lock chamber with either vertical slide gates located in or adjacent to the gate bay monoliths. The filling and emptying system having the maximum effect on the structural design and layout of locks is one with culverts in the lock walls. Many types of valves have been used including vertical lift gates, butterfly valves, cylinder valves, and tainter valves, both direct and reversed. Plate 34 shows a layout of a reversed tainter valve. All recently built locks with wall culverts have

used the reversed tainter valve. In the interest of economical construction and steel fabrication, all tainter valves for a lock should be identical and should be located in the lock walls close to the gate bay monoliths where the tops of the walls are wide. Valve pits should extend from the tops of the lock walls down to the culverts, thereby allowing the completely fabricated valve to be lowered through these pits for installation or removal. The filling and emptying control valves are critical components, and an outage can cause delay or disruption of barge traffic or even shutdown of the lock. Since the lower portion of the valve skin plate is subjected to negative pressure which could destroy protective coatings and cause cavitation damage, it should be made of corrosion-resistant steel. Cathodic protection of the sacrificial anode type should be provided. The shape of the valve body is extremely important and the latest recommended shape can be obtained from the Waterways Experiment Station. Reference is also made to EM 1110-2-1610 for layout and design details.

a. Design requirements. In the design of modern lock filling and emptying systems, the following conditions must be met:

(1) Filling and emptying operations should be performed as rapidly as possible without sacrificing safety, or incurring excessiveness costs.

(2) Disturbances caused by the flow of water during the operation should not endanger any craft that may be in the lock chamber or in its approaches. Localized turbulence can be generated by jets of water which the filling and emptying systems introduce into the lock chamber or lower approach. This disturbance may cause considerable damage to the individual components of a tow or smaller craft. An oscillatory, longitudinal surge can occur in the lock chamber during operation of the filling or emptying system. This disturbance is more serious since the possibilities of damaging both craft and structure are greater. To avoid damage to vessels and structures, it may be necessary to reduce the filling or emptying rate far below the design capacity. Because surging tends to cause a vessel to drift from one end of the lock chamber to the other, the vessel must be restrained by hawsers (lines) to keep it from striking the gates or damaging other parts of the structure. Vessel operators are responsible for providing the hawsers required to restrain their craft. The stress in the hawsers is essentially a function of the gross tonnage of the tow and the slope of the water surface in the lock. The frictional forces exerted upon the craft by flow in the chamber have only minor effects on the stress. To prevent the high hawser stresses caused by

surges, newer locks have incorporated an automatic control system for valve operation which prevents overflow and overempty of the lock chamber.

b. Features of commonly used systems. Detailed model studies of the filling and emptying systems most commonly used have been made by the Waterways Experiment Station. (Proposed systems that have not been model tested should be evaluated to ensure that design expectations can be met.) The studies plus followup prototype experience showed that the main features of a filling and emptying system must be constructed to very close tolerances. Those features requiring careful detailing and layout are the culvert intake manifolds, the culvert proper, the discharge manifolds, the chamber ports at the lock face or the structures in the lock chamber, the filling and emptying valves, and the bulkhead recesses just upstream and downstream of the valves. The following heights are applicable to the "lifts" mentioned in the following paragraphs: low lift under 30 ft, intermediate lift from 30 to 50 ft, and high lift over 50 ft.

(1) The most common system is the wall ports system. It consists essentially of a longitudinal culvert of constant size in each wall, each with suitable intakes from upper pool, a filling valve, a series of chamber ports, an emptying valve, and a discharge manifold into the lower pool. Chamber ports are usually rectangular in shape, spaced at intervals which are staggered in the two walls; however, several locks have been constructed using a multiple system of small circular ports arranged in two or three horizontal rows. For steel sheet pile locks or others having concrete gravity walls limited to the gate bays, a system of short loop culverts may be used. Two filling culverts extend from the upper pool around the upper gates into the lock chamber. A similar pair of culverts extend from the lock chamber around the lower gates and discharge into the lower pool. Other systems include filling around partially opened upper lock gates (when sector type service gates are used), or filling over or under the upper gates when tainter or vertical lift service gates are used.

(2) In the bottom lateral systems for high-lift locks, the simple wall ports used in low or intermediate lifts are replaced by laterals extending across the lock chamber below floor level. The flow is discharged into the lock chamber through a number of ports in each lateral. In early lock design which used the bottom lateral system, the individual ports were in the roof of each lateral. This design works satisfactorily with a deepwater cushion but may not be suitable for the shallower cushion available in

barge locks. More effective energy dissipation can be obtained by locating the ports in the sides of each lateral, so that adjacent laterals will discharge into the common trench or box between them. If ports in adjacent laterals are staggered, an even better stilling action will result. The width of each lateral should decrease from its culvert connection to the opposite wall to produce a uniform flow through all ports. Two types of lateral systems have been used: the intermeshed type and the split type. In the intermeshed type, laterals from one culvert alternate with the laterals from the opposite culvert. The entire system is contained in about the middle third of the chamber and produces excellent results if the tow is placed symmetrically over the laterals. However, unsymmetrically placed tows will experience much higher hawser stresses during filling operations. The higher stress can be overcome by the split lateral system in which one culvert feeds a set of laterals in the upstream half of the lock chamber, while the second culvert feeds a similar set of laterals in the downstream half. Since each set of laterals receives the same amount of water, longitudinal currents in the lock chamber are held to a minimum, and hawser stresses will be almost identical regardless of the location of the tow. However, this split lateral system cannot be operated safely with one valve unless the filling and emptying time is greatly increased. A third type of bottom filling system, the bottom longitudinal system, has been developed and refined in the past 25 years. It uses longitudinals in the lock floor connected to the wall culvert. This system is the most sophisticated system developed to date for high-lift locks. This system is expensive for it requires a highly configured concrete structure in the lock chamber. In addition, its use could possibly cause lowering of the culvert monoliths to obtain the proper water depth over these chamber structures.

c. Intake manifolds. Culvert intake manifolds are usually located in the face of the lock wall just upstream of the upper sill. However, depending on individual situations, the intake may be on the other side of the lock, or in the upper sill, or taking water from both sides of the wall, or located away from the walls (in some rare cases). The ports at the face of the lock wall are of uniform shape and size. The area of the intake at the face of the lock wall should be considerably larger than the culvert area to reduce velocities and entrance head losses. This larger area also prevents damage to trash racks from impact of floating drift or ice, minimizes vortex formation, and lessens the tendency to draw air into the system. For structural reasons, several smaller intakes are preferable to one or two large ones. Intakes should be submerged below minimum pool a distance not less than the velocity head at the face of the wall to avoid vortices.

Since each successive port in the downstream direction is subject to increased pressure differential, each throat is made smaller to obtain approximately equal flow. The culvert converges between successive ports but expands abruptly immediately downstream from each port. This sudden expansion increases the pressure in the culvert to match the inflow from each succeeding port at its point of confluence and thus reduces impact losses.

d. Longitudinal culverts. These culverts usually measure the same size from the intake manifold end to the beginning of the discharge manifolds, and the valves usually have the same rectangular dimensions. However, in some designs, the valves and culverts may be different sizes, and the culverts may expand in height between the filling and emptying valves to obtain certain filling characteristics. The layout of the culverts in the lock wall should allow sufficient concrete thickness between the culvert and the lock face and between the bottom of the culvert and the foundation in order to satisfy all loading situations. The roof of the culvert should be at least 3 ft below minimum tailwater elevation to prevent air entrapment.

e. Discharge system. This system should be designed to achieve an efficient emptying operation and distribute the outflow from the lock at locations and velocities which will not imperil any craft in the immediate lock approach area. The system may be located either in the lock walls, as laterals in the lock approach floor, or at a location away from the lock approach. Whenever practicable, the best type of discharge is one which diverts the entire flow outside of the lock approach. For such a layout, alternate designs could include crossover culverts with stilling basin and exterior side ports systems where sediment is a problem. Use of exterior discharge allows the planner to shorten the lock but requires a lengthening of the short approach walls and sediment collection problems may result. For this type of layout, each culvert discharge should be provided with a stilling basin to prevent high velocities from extending all the way across the lower pool and producing reflected eddy currents in the lower approach. If this type of emptying system results in a head differential between the lock chamber after emptying and the lower approach, the design of the lower gates and operating machinery may be affected. In extreme cases, it may be necessary to provide an auxiliary emptying valve to equalize the residual head differential.

f. Lock chamber wall ports. Side wall ports in the lock chamber are rectangular, usually venturi-shaped, with the larger area at the chamber face. They should have a rounded entrance at the culvert to increase efficiency in

filling and a smaller radius at the wall face to improve entrance conditions during lock emptying. Dissipation of energy during filling is improved by staggering the ports in the two walls, so that the jets issuing from one wall pass between those from the opposite wall. Thus, the jets travel twice as far horizontally and are more diffused when deflected upward by the opposite wall. Spacing of ports on 28-ft centers in each wall of a 110-ft-wide lock will allow the jets to pass one another with only slight intermixing at their boundaries. Somewhat closer spacing may be used on narrower locks. Ports should be inclined downwards slightly for best results. With the 28-ft spacing, ports should be located approximately at the middle half of the lock chamber, symmetrically between the gates. Total area of ports at their smallest section should be about 0.95 times the culvert area. To avoid reverse flow from the chamber into the culvert, the hydraulic gradient in the culvert at the upstream port should be higher than the water level in the lock chamber. Placement of deflectors in front of the first few upstream ports helps to reduce surges in the lock chambers.

g. Lock chamber laterals. High-lift locks are usually equipped with floor laterals rather than wall ports. The two types of lateral systems that have been used are the intermeshed type and the split type (see Plates 6 and 31). Each lateral has pairs of rectangular ports discharging horizontally to either side of the lateral. Pairs are spaced about 12 to 14 ft apart on centers along the lateral. Ports in adjacent laterals are staggered to force their discharges to pass one another. The cross-sectional area of each lateral narrows from where it begins at the culvert to where it ends at the opposite lock wall to provide a uniform flow distribution. This narrowing occurs through a standard height and a width which either tapers steadily or narrows in successive steps between ports. A height to width ratio for ports of about two is recommended, and their length, exclusive of radii, should be no less than three times their width. If the lateral wall is not thick enough to obtain this length, port extensions should be provided. The clear space between each lateral, available for diffusion of discharges from the ports, should be no less than five times the port width. Intermeshed laterals should be located in the middle third of the lock chamber. In a split-lateral layout, each group of laterals should be located in the middle third of its respective half of the chamber. Lateral filling systems permit the lock chamber to fill more rapidly than wall ports. In all bottom lateral systems, the operation of the filling valves in each culvert must be synchronized to ensure equal discharges through each set of laterals. Unequal discharges will increase longitudinal surges in the lock chamber and produce higher hawser stresses.

h. Bottom longitudinals. Bottom longitudinal filling and emptying systems were developed to overcome the weakness of bottom lateral systems to nonsynchronous operation of the culvert filling valves. These systems are designed to admit water simultaneously through a number of ports, all of which are equidistant from the center of the lock in travel time. For this operation, the main culverts are directed to the center of the lock and through large laterals to two or more longitudinals, running upstream and downstream in the floor of the lock over most of its length. These longitudinals are equipped with pairs of side ports which are similar to those found in the bottom lateral system. The ports are arranged in a symmetrical pattern to obtain an even flow distribution throughout the chamber. Millers Ferry Lock on the Alabama River was one of the first projects in the country to incorporate bottom longitudinals. An improved system for a lock with a lift of 100 ft was developed for the Lower Granite Lock on the Snake River. In this project, the main culverts were increased in area by about 50 percent to improve pressures below the valves. One of the more recent projects which uses the bottom longitudinal system is the Bay Springs Lock on the Tennessee-Tombigbee Waterway. To maintain a constant velocity, the distributing laterals and longitudinal subculverts are sized in proportion to their discharge. Area of ports in each longitudinal is about 0.85 times that of the subculvert, and total area of ports is about 1.2 times the culvert area at the filling valves. The bottom longitudinal system has an important advantage in that the main lateral at the center of the lock is connected to both main culverts; thus the lock can be filled or emptied through one main culvert (assuming the other is inoperative due to culvert valve repair or other cause) while maintaining a balanced filling or emptying operation. Also, with both main culverts in use, the chamber can be filled more quickly without exceeding allowable hawser stresses.

i. Multiple wall ports. This system consists of a large number of small circular ports, 8 to 10 in. in diameter, at about 3 ft on centers, arranged in two or three horizontal rows. From 200 to 300 ports are used in each culvert, depending on the chamber size. They discharge below the lock chamber floor level into a longitudinal trench about 3 ft wide and 6 to 8 ft deep. Each port flares at both ends, and slopes down toward the trench at an angle of about 15 deg. Total area of ports for each culvert is about 0.95 times the culvert area at the filling and emptying valves. The ports are distributed over somewhat more than the middle half of the chamber. Culverts are generally enlarged throughout the port area by some 25 to 30 percent either by raising the culvert ceiling or by widening it. Model tests conducted by the

Tennessee Valley Authority (TVA) on this type of system emphasized the utmost importance of forming a tight seal between the filling valves and the upstream ports to prevent entrance of air into the system. This type of filling system is suitable for use in a site where the lock wall foundations are considerably lower than the lock chamber floor. The trench can be either excavated in the rock or formed by concrete retaining walls. The TVA was successful in using this system on several locks on the Tennessee River with lifts up to 60 ft. It was also used on the Corps of Engineers Cordell Hull Lock on the Cumberland River as well. The major disadvantage of this system is that the culverts cannot be accessed from the lock floor.

j. Culvert valve layout. The reversed tainter type culvert valve (sometimes referred to as a segmental valve) has been used in most of the locks recently built in the United States, although vertical lift (stone) valves, butterfly valves, and cylinder valves have been used in the past. Until the advent of high-lift locks, tainter valves were installed with the skin plate positioned upstream and the arms in compression. As the head increases, the pressure gradient just downstream of the valve drops below the top of the culvert and thus allows large volumes of air to be drawn into the system. The explosive release of air into the lock chamber during lock filling caused hazardous disturbances to small craft and decreased the efficiency of the system. The pressure below the valve was increased, and the air problem at the valve pit was eliminated by reversing the valve, so that the skin plate was downstream and the arms were in tension. This arrangement also converts the valve pit into a surge chamber, which relieves waterhammer stresses on the valve that might otherwise occur during a sudden closing due to structural or mechanical failure. A more detailed discussion of lock tainter valves is contained in EM 1110-2-1610. A short discussion on valves in other types of filling systems also appears in the same referenced work.

k. Culvert bulkhead recesses. Culvert bulkhead recesses are provided upstream and downstream from culvert valves to allow bulkheads to be lowered into place to close off the individual valve chamber to conduct valve repair. A lock of double culverts can function even when one culvert is closed since the lock can be filled and emptied through the other culvert at a reduced rate of speed. When the height of the walls is sufficient, hangers for storing the steel bulkheads in the recesses are often provided near the top of the walls for quick and easy access in case of valve problems. These culvert bulkheads are not designed to be lowered in flowing water. When only a slight amount of submergence can be

obtained, the control valves and downstream bulkhead recesses are sealed. This type of system is provided through use of the reverse-type tainter valve which seals on the downstream face of the valve recess. Air is prevented from entering the culvert through the downstream bulkhead recesses through a removable water-seal diaphragm a few feet below the lower pool level. With such an arrangement, a passageway from the valve pit leading into the lower bulkhead recess keeps this recess to upper pool level to maintain a water load on the diaphragm at all times. A valve in the sealing diaphragm can be operated above upper pool to allow drainage of the recess to lower pool level and removal of the diaphragm when the bulkheads must be inserted.

5-4. Lock Walls

a. Chamber walls. The top widths of concrete land walls for lock chambers are usually 6 to 10 ft. In addition, the top widths of both the land and river walls may have to be sized to allow passage of a mobile rubber-tired crane or other utility vehicle. Other shape requirements are governed by galleries, conduits, and openings required for operating facilities and accessories, as well as by the general stability requirements for all loading conditions.

(1) Land walls are subject to horizontal loads from fill on the back of the wall. This fill may extend to the top of the wall on low or moderate lift locks, or it may end some distance below the top of the wall at high-lift locks.

(2) When the discharge through the dam is adjacent and parallel to the river wall, the river faces of the walls are often constructed to provide smooth flow conditions. If the riverbed is composed of erodible material, special construction will be required at the foundation level or at the river face of the wall to prevent undermining of the wall. Also, riprap and graded stone should be placed along the lock wall. The predominant load that river walls are subjected to are hydrostatic loads. The hydrostatic load combinations are due either to upper pool level in the lock chamber and lower pool level below the dam or to water outside the lock with the chamber unwatered for repairs or inspection. The hydrostatic forces involved in the river wall design will vary with respect to whether the section is above or below the dam, with the latter situation usually requiring the least volume of concrete in the wall. For economic reasons, therefore, the lock chamber should be located downstream of the dam unless some overriding factor exists.

(3) An intermediate wall for the lock chamber is required for dual, side-by-side lock construction or where provision is made for the installation of a second lock at a later date. The width of the top surface of the wall is determined by the width of the bottom of the wall. The two wall faces that form the sides of the two locks cannot be offset to obtain a narrower top width in the lock chamber, because the tows must rub against continuous straight surfaces as they pass through the lock. Smooth vertical surfaces are also needed for mooring during lockage. The volume of concrete can be minimized by leaving an earth-filled space in the center of the upper part of the wall. An alternative approach would be to leave a void in the middle of the structure, rather than inserting fill, to reduce the amount of concrete used and the load on the foundation. Also, the structure must be designed to prevent leakage from either of the lock chambers entering the other when the pools are not equalized. This type of structure can be accomplished by using waterstops in the monolith joints, by placing a steel sheet pile cutoff wall along the full length of the base of the walls when the foundation consists of pervious material, or by grouting the foundation when rock is the supporting medium.

b. Upper and lower gate bay walls. The top width of gate bay walls should be sufficient to house the operating mechanism, provide space for the gate anchorages, and enclose the valves. It should also allow the gates to be recessed flush with the faces of the walls (for miter and sector gates) and provide a sufficient thickness of concrete between the culverts and the gate recesses. These portions of the wall must resist the concentrated gate loads in addition to the lateral earth pressure or hydrostatic loads as do the lock chambers. The length of monolith must be adequate to safely distribute the gate loads. Also, the gate operating machinery is usually supported on the same monolith containing the miter gate support (pintle and top anchorage) to prevent any misalignment or relative movement between gate and machinery.

(1) Loaded miter and sector gates cause overturning moments in two directions on the lock walls. These loads must be accounted for in computing wall stability. Gate bay monoliths should be analyzed as three-dimensional units for stability and internal stresses with all forces calculated in both the transverse and longitudinal directions, and the resultant located with respect to the kern area of the base.

(2) Other types of gates transfer their loads parallel to the lock face; therefore maintaining wall stability is not as critical. However, the length and stability of such a monolith must still be carefully analyzed. The design of the downstream gate bay monoliths for high-lift locks requires two monoliths with monolith joints that are properly grouted to allow the two to act as a unit to satisfy stability requirements. If thin reinforced concrete sections are used, the walls should be analyzed for effects of twisting caused by the eccentric gate thrust. However, in gravity walls this type of load can usually be absorbed by the concrete in the supporting monolith.

(3) Loads from vertically framed miter gates have less effect on lock wall stability than do loads from horizontally framed gates, because the vertically framed type transmits a considerable portion of its load to the miter sill while the horizontally framed type does not. However, the loads from these two gate types cause about the same overturning effect on the wall. The sill for the vertically framed gate must be designed to withstand part of the water load. The miter gate operating strut load has a negligible effect on the overall wall stability. However, local stresses are high at the anchorages for the struts. Strut loads of significant magnitude are caused by the resistance offered by the water to opening or closing the gate leaf.

c. Bulkhead monoliths. Bulkheads should be provided to unwater the lock chamber and gate bays. Providing bulkhead slots is recommended to ensure that individual lock gate bay monoliths can be unwatered. These bulkheads, slots, and sills can be placed either in the gate monoliths or in separate monoliths. In either case, these wall and sill monoliths should be analyzed for stability for the full unwatered condition.

d. Culvert valve monoliths. Valve pit design must consider the maximum differential hydrostatic loadings that can occur between the valve pit and the lock chamber under all possible operating conditions. Valve pit walls are often subject to combined axial tension and bending which increases steel reinforcing requirements and cracking potential.

e. Culvert intake and discharge monoliths.

(1) Intake walls which extend immediately upstream beyond the upper gate bays provide space for intake ports leading to the culverts. These wall extensions are often made with wide top surfaces for three reasons: (a) to support bulkhead handling machinery when temporary closure structures are used; (b) to provide bulkhead

recesses, crossovers, risers, and gage wells; and (c) to leave space for other incidental equipment. These walls are usually as high as the lock walls. The bulkhead slots may be located upstream or downstream of the culvert intakes. For low-head lock projects, particularly canal locks, the upstream location is more adaptable. For higher head locks, the bulkhead is usually located downstream of the intakes, primarily because combining the bulkhead sill with the upper service gate sill is more economical. Unwatering of the intakes is not a critical function, since the only items needing maintenance are the intake trash racks. Special provisions for easy removal of the trash racks should be incorporated in the design.

(2) Discharge walls are located immediately downstream of the lower gate bay monoliths and extend far enough to allow the emptying culverts to exit the lock walls. The tops of discharge walls may be lower than the chamber walls, and they are usually at the same level as the adjacent lower approach walls. Maximum navigable tailwater governs the top level of these walls. Many different layouts and configurations are designed to diffuse and dampen the velocity of the water while the lock is being emptied. Model studies are usually conducted to determine how to accomplish this diffusing and dampening.

5-5. Approach Walls

Providing approach walls at each end of a lock facilitates lockages by reducing hazards and increasing the ease of the entrances and departures of tows. Because of the high cost of these features, the requirements for each project should be studied to ensure an economical solution. Plates 21 and 22 indicate the location of approach walls with respect to a lock. Loads that such walls may be expected to withstand are covered in Chapter 8.

a. Location. Historically, longer approach walls have been located on the landward side of a lock. This location facilitates operation close to the riverbanks when adverse currents make navigation difficult. This arrangement also confines lock operation activities to the landward wall which usually is more convenient. However, the location of approach wall must also account for other factors. For example, if the draw of water toward the dam on the upstream side causes crosscurrents in approaches, or if there is a slow upstream eddy in the lower approach, then it may be advisable to locate the longer approach walls on the riverward side. Additional concerns affecting location include prevailing winds, which may add to the tendency of the tow to move toward the dam, or the provision of tow haulage

equipment. To determine the best arrangement of approach walls, model studies should be conducted covering a range of upper pool conditions coupled with a variety of spillway discharges. In some previous projects, model studies have shown the need for an upper approach wall that is longer than the lock chamber because of excessive draw caused by spillway discharges. Also, the same model studies have shown that rock dikes, which extend from the lower approach wall at an angle, are necessary to control adverse currents caused by spillway discharges. Unless site conditions dictate otherwise, locks should have the longer upstream and downstream approach walls on the same side of the lock. This rule applies particularly to walls containing tow haulage units and movable weirs, since with these two items the tow lockage can be continuous on the same wall. In canals, it may be advisable to locate the longer wall on the side toward which the prevailing wind blows. At locks used principally by ships, it may be desirable to locate the longer walls to port since most ships berth easier on the port side. If no valid navigational reasons exist for selecting one side over the other, the longer walls should be located on the side most convenient for lock operation.

b. Length. A general rule for the longer approach walls is that their length should equal the usable length of the lock chamber unless conditions dictate a longer wall. For example, if a majority of tows are longer than the chamber, then provisions should be made for a longer wall. In locations where the nature of the boats or the rockiness of the banks makes it impossible for tows or ships to nose safely into the natural banks during emergencies, the walls may need to be lengthened to provide mooring space for more than one ship or tow at a time. In these instances, consideration should be given to using mooring piers or sheet pile cells rather than longer walls. If an approach is located in an area that is protected from wind and has no adverse currents, the length of the approach wall may be reduced. Shorter approach walls often are built on the side of the approach opposite the longer walls. The requirements for shorter approach walls are always associated with specific local conditions. However, the shorter approach wall, or an approach wall supplemented with a cell, should be configured to prevent tows from hitting the lock gates or the ends of lock walls. Dual locks, separated locks, and side-by-side locks also have special site-specific needs for approach walls. In these cases model studies and conferences with tow operators and district operations personnel will provide valuable guidance for approach wall requirements.

c. Alignment. In general, the longer approach walls should be straight-line extensions of the lock walls. This

requirement is especially important at locks dealing with tows. Shorter, opposite side walls (if used) are often flared for their entire length.

d. Types. In selecting the type guide and guard walls for a specific project, consideration should be given to designing walls that can be constructed in water without using a cofferdam. In past projects, this type of construction has proven to be cost-effective. However, the walls must be carefully designed and constructed since extensive and repetitive maintenance costs over the life of the structure could offset the original savings. Furthermore, traffic disruption or stoppage could be a major problem with added costs to the towing industry and shippers.

(1) Mass concrete or reinforced concrete walls. These walls are usually built within cofferdams and can be founded on rock, soil, or bearing piles. They are designed to meet all stability requirements for overturning and sliding with appropriate loads applied for barge impact, line pull, and earthquakes. These walls must be reinforced to resist all anticipated loadings. For ported walls, corbels (brackets) are usually provided on the sides of each pier to support the first concrete lift above the ports. This first placement contains reinforcement to support the additional lifts of the wall above.

(2) Cellular supported. Cellular supported guide walls can be built in water without a cofferdam. The supporting element of the wall is composed of steel sheet pile cells--either intermittent or continuous depending on requirements for the wall. An intermittent line of cells can be made into a continuous solid wall by driving a single line of steel sheet piling between cells. The cells can be filled either with granular material or with tremie concrete, with or without bearing piles depending on foundation conditions. In addition to stability requirements, the cells must be designed to withstand interlock tension stresses in the sheet piling. A granular filled, cellular supported wall usually has the end cell filled with tremie concrete since the wall supported by this cell will receive the greatest blows from incoming tows. Close control must be exercised during pile driving to assure that no "windows" exist in the piling which could cause loss of fill. If piling cannot be checked with confidence during pile driving, then a diver should check for "windows." Concrete that has been put in the cells by tremie should also be carefully monitored during placement and each lift line thoroughly cleaned and checked, since coring of some tremie concrete on previous projects has revealed many voids. The concrete wall supported by the steel cells may be designed either as precast or

cast-in-place or as a combination of the two, depending on water levels.

(3) Prefabricated concrete beams. Prefabricated beams, either reinforced or prestressed, are usually used to make up the portions of the wall which are under water. The part of the wall above water may be cast-in-place. Since these beams span from cell to cell and since cells cannot be constructed in an exact location, engineers should precisely set the lengths of these beams and accurately position the bearing surfaces on the cells. Past experience also indicates that providing a tremie concrete "make-up" placement between the ends of adjacent beams compensates for unavoidable construction inaccuracies. The beams should have tongue and groove surfaces on the tops and bottoms plus installation and stacking guides, so that placing and positioning in the water is made easier and the faces of the wall will not be offset between beams. Casting of the beams on top of each other in the shop and numbering the beams to be in the same location in the wall will also help. The beams must be designed for transportation loadings, construction loadings, and typical guide wall loadings.

(4) Caisson supported. Caisson-supported guide walls can be built in water where foundation and water flow situations preclude the use of steel pile cells for wall support. The only use of this type support by the Corps was the main lock (110 × 1,200 ft) upper guide wall at Melvin R. Price where six 6-ft-diameter steel caissons were used for each monolith. The caissons were driven to refusal at very hard material. Each caisson was cleaned out down to the beginning of the hard material and was then filled with concrete. The first caisson that was driven and filled with concrete was load tested for confirmation of the safety factor used for the design loading. The concrete wall on top of the caissons was cast-in-place and was designed somewhat similar to that for a cell-supported wall except that a heavy structural steel framework was provided for transfer of the wall loads to the caissons. The last upstream monolith was protected by a full height steel pile cell driven to 30 ft below streambed and filled with concrete. A steel sheet pile curtain wall was hung from the bottom of the wall on the dam side to attenuate the velocity of the water flowing under the wall. Also, stone protection was placed on the bed of the river and around the caissons to prevent erosion of material from around the caissons.

(5) Floating guide walls. In previous projects where upper pools are very deep, floating approach walls of concrete have been used successfully. The floating wall is composed of watertight cells with sealed inspection

manholes surmounted by a vertical buttressed concrete or steel wall on the traffic side. The wall should be designed so that the concrete weight is distributed to make the wall float level at the proper submergence. The structure is a completely reinforced concrete design with the ability to resist impact from tows. However, heavy timbers must be provided on the traffic side to protect the concrete from barge rubbing and scraping and to distribute and dampen the impact forces from tows. These floating walls are hinged to the upper end of the main lock walls through a wheeled guide operating in a vertical recess, similar to a floating mooring bitt. A shock-absorbing device is also incorporated into the connection. The upstream end of the floating wall is anchored by adjustable cables fastened to dead men on the lake bottom. These adjustable cables allow the wall to be kept in proper alignment with the face of the main lock wall. An additional set of cables is provided as a safety backup in case the main cables fail.

(6) Sheet pile guide walls. Steel sheet piling in a double row, connected by diaphragms or tie-rods and filled with free draining material, has been used for guide walls with and without concrete on top. If the wall furnishes support for a concrete wall above, steel bearing piles can be used inside the piling enclosure. If site conditions are favorable, a single line of piling anchored into the material behind the wall with tie-rods can be used.

(7) Timber guide walls. Timber guide walls are used mostly on intracoastal waterway locks where the lifts are relatively low.

(8) Ported guide walls. Ported guide walls are designed primarily for upper approach walls adjacent to the dam spillway. The estimated size of the ports is determined from model tests. The ports should have adjustable features. When water is flowing over the spillway, flow through these ports can be regulated to prevent adverse navigation conditions for tows entering and leaving the lock chamber. The wall may be either a cellular supported wall or a reinforced concrete wall on piers. Steel sheet piling and precast concrete panels have been used to provide the adjustment capability for the ports.

5-6. Lock Sills

a. General. As discussed in Chapter 4, the sills may or may not be connected monolithically with the lock walls. Connecting the sill with the lock walls is usually beneficial in terms of the sill overturning or sliding in the upstream/downstream direction and may eliminate problems with inadequate bearing capacity of foundations

under the adjacent lock walls since the vertical loads of the walls can be distributed to the sill foundation. If the sill is not connected to the lock walls or founded on rock, its stability may depend on use of bearing piles. The monolithic connection may be advantageous from an operational point of view in that it inhibits lateral movement of lock walls which could be detrimental to gate operation.

b. Navigation depths. Typically, the lock gate sill elevation is higher than the adjacent lock floor and other sills. It is set low enough to provide a cushion between the bottom of the vessel and the top of the sill. This cushion is required for hydraulic reasons and to allow for coatings of ice on the hulls of the vessels and for certain other contingency items. A description of the sill depth requirements for barge traffic is provided in EM 1110-2-1604. In some cases, there may be justifiable requirements for depths greater than that described in the reference, such as to allow limited navigation through the lock in the event of loss of upper pool. However, regulatory and legal requirements may preclude such variation.

c. Lock gate sills. Sometimes, the gate sill masonry can be utilized to form intake ports for culvert filling and emptying systems and for crossovers containing the various utilities. Some of the various types of gate sills are outlined below. For gravity locks, the sills are usually cast separately from the lock walls; however, with U-frame-type locks, the sill is cast monolithic with the lock walls.

d. Gate sill loadings. Sills must be designed for vertical and lateral water and earth pressures and for forces induced by uplift and foundation reactions. Generally, the lateral loadings occur between the elevations of the bottom of the gate and the foundation and act in the upstream/downstream direction. If the sill is monolithic with the lock walls or serves as a strut between the walls, the sill design must include the loads induced by the connection to the lock wall. The gate sill is required to resist a portion of the gate load when using vertically framed miter gates, or wide tainter gates having intermediate trunnion supports, or rolling gates. Where the gate sill abuts adjacent sills or walls, the presence of waterstops may eliminate or cause the joint water pressure to be different from the pressure which would result from the joint being exposed to the adjacent pool. The design should consider joint pressures based on ruptured waterstops if such condition would be more critical than with the waterstops being fully effective.

(1) Horizontally framed miter gate. Sills for horizontally framed miter gates are used to provide a sealing arrangement and to form the damming surface below the gate. Horizontally framed miter gate sills are not required to resist any part of the gate thrust, since the entire thrust load is transferred to the lock walls. The gate gravity load is supported on pintles located adjacent to each lock wall. The pindle will generally be supported by a ledge extending from the lock wall; however, in the case of U-frame-type locks, the zone of influence of the pindle forces will extend into the lock sill.

(2) Vertically framed miter gate. Sills for vertically framed miter gates differ in design from sills for horizontally framed gates only in the method of load application from the gate. The horizontally framed gate load is taken as a thrust into the lock wall; whereas, a portion of the vertically framed gate load is taken by the sill. Miter gates with this type framing system will normally not be provided on modern locks.

(3) Lift gate. Lift gates do not transfer any water load to the sill. The sill provides a sealing surface, and in addition, the sill forms a spillway weir for passing discharges during flood stages where the lock is designed for such uses. In some conditions, the sill is required to support the full deadweight of the gate such as in the unwatered condition.

(4) Sector gate. Sills for sector gates are used to form the sealing surface for the gates and frequently to provide rolling tracks to carry a portion of the deadweight of the gates. However, supporting the gate on rolling tracks can present problems with keeping the rolling system operable and clear of obstruction. Water loads are distributed through the gates to rotating shafts located adjacent to the lock walls. The shafts in turn are supported by a hinge at the top of the lock wall and a pindle at the level of the sill, similar to miter gates. The sill also acts as a damming surface beneath the gates.

(5) Tainter gate. Tainter gate sills are of two distinct types from the standpoint of the loads which they are required to resist; however, for each case the hydrostatic and lateral earth pressures must be included in their design. The one type of sill merely provides a sealing surface for the gate and a top surface to fit the required spillway characteristics. This type of sill is practicable only for narrow lock chambers when the entire gate load is transferred to the lock walls through end trunnion arms. The other type of sill is one used for wide lock chambers

where end and intermediate trunnion arms transfer their loads to trunnion castings anchored to buttresses attached to the sill.

(6) Roller gate. A rolling gate sill consists of a straight concrete structure across the lock floor with embedded tracks upon which the gate rolls. Loads which the sill must resist are similar in nature to those of the vertically framed miter gate sill, the difference being in the determination of the total gate thrust and the dead-weight of the gate. Rolling gates in the United States were developed for use on wide locks with comparatively low lifts.

e. Emergency closure sills. Closure structures other than the service gates at each end of a lock are sometimes considered necessary in order that flow through the lock chamber can be stopped if the gates should become inoperable. These closure units are also used to close the lock chamber to permit unwatering for periodic inspections and repairs. In order for these structures to seal at the bottom and have a base for support, a sill is provided at, or a slight distance below, the elevation of the gate sills in many existing locks. Some recent installations have these closure sills outside the intake and discharge openings of the filling and emptying system in order that the latter elements may be conveniently inspected and repaired. For structures on pervious foundations, a row of steel sheet piling may be driven under the sill as a cutoff, and when on rock, pressure grouting may be utilized.

f. Bulkhead and temporary-closure sills. These sills are normally located both upstream and downstream of the lock gate sills and provide both bottom support and a sealing edge for bulkheads, stoplogs, etc. The top elevations for these sills will be lower than the adjacent gate sills and, in some cases, may be approximately the same level as the adjacent lock floor elevations. In some cases, these sills also serve as the lock floor and may be cast separately or monolithically with the lock walls similarly to the gate sills.

(1) Bulkhead sills. Bulkhead sills are not required to resist any part of the bulkhead lateral load. Thus, the sill structure needs be designed to support only the weight of the bulkheads and to resist the hydrostatic pressures below the bottom unit. An advantage of the bulkhead type of closure unit, if properly designed, is that a positive seal can be effected without the services of a diver during installation. However, lowering carriages or special hoist cars are usually needed to assure installation in flowing water as it is possible that a single (or unballasted) bulkhead will not sink in flowing water.

(2) Poiree-dam sills. Poiree-dam sills differ from bulkhead sills in that they resist the full hydrostatic load on the closure. The lock walls form the sealing surface at the ends. The sill contains the structural anchorage to which the A-frames are attached to support the needed damming surface. Because of the complications of attaching the frames to the sill anchorages, the services of a diver will be needed during installation of the frames.

(3) Needle-dam sills. Needle dam sills are generally used on narrow or shallow draft locks. A horizontal girder is placed in recesses in the lock walls, and the needles rest against it at the top and against a recess in the sill at the bottom. The sill resists about two thirds of the horizontal load on the needles and the total hydrostatic and earth pressure thrusts below the damming surface.

(4) Other closure methods. Other types of closure methods are possible and have been used such as float-in bulkheads. Loadings and the corresponding sill would be similar to those required for conventional bulkheads. The principal difference would be the method of bulkhead installation. For shallow draft locks, an earthen embankment could possibly be used on the downstream end of the lock. In any event, the logistics of closure including methods, costs, time constraints, and availability of closure handling equipment should be considered in selecting the types of closure systems to be used.

5-7. Gate Types and Locations

The type of lock gates must be determined early in the design since this can have significant impacts on the overall lock layout. Various types of gates are discussed in Chapter 7.

5-8. Lock Closure

a. Maintenance closure. A maintenance closure system for use in unwatering the lock should be provided in case it becomes necessary to repair the lock gates or other underwater items. When practical, locks should be designed to allow for full unwatering of the lock chamber by using the uppermost and lowermost bulkhead recesses in the lock walls. The most common type of maintenance closure consists of lock bulkheads installed by floating crane. However, allowable downtimes, traffic, and economics may dictate the use of more rapid system with permanent onsite equipment readily available for closure. A typical bulkhead closure system is shown in Figure 5-2.

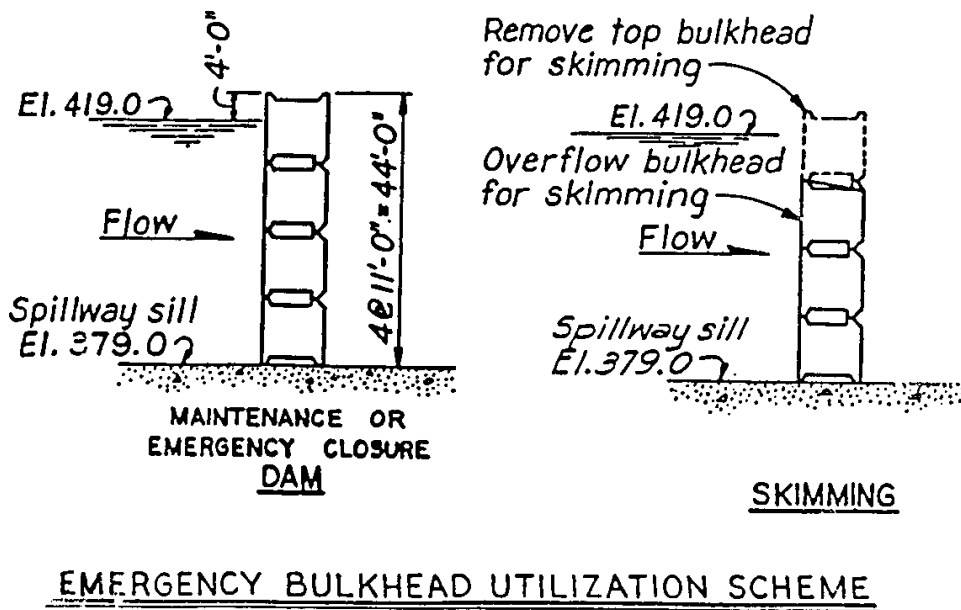
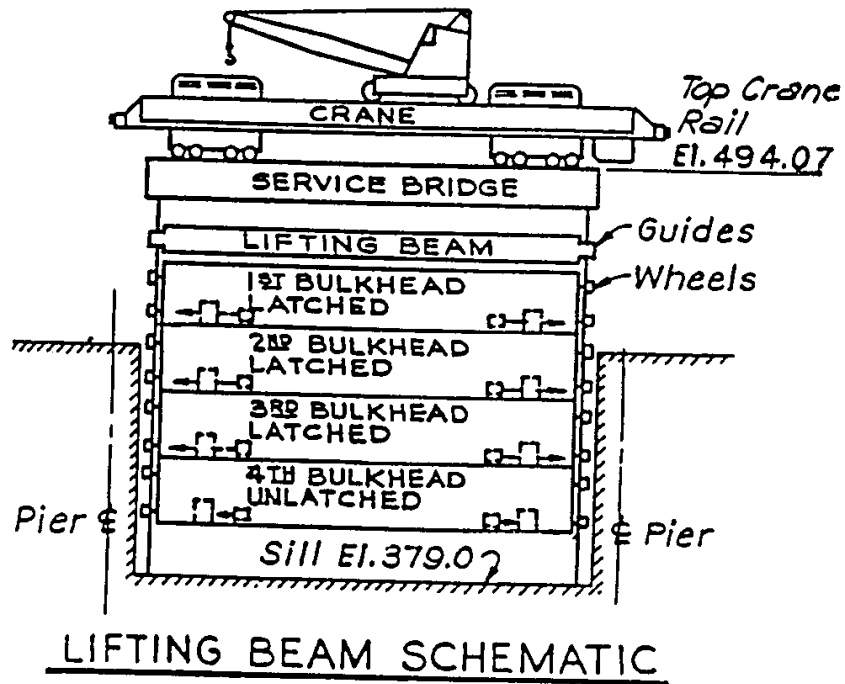

Figure 5-2. Typical bulkhead closure systems

b. Emergency closure. Sometimes it may be necessary to build emergency closure structures in addition to service gates to ensure that flow through the lock chamber can be stopped if the gates become inoperable. The decision to install emergency closure system is made on a project by project basis and depends on such factors as the likelihood of pool loss, extent of damage which could be caused by pool loss, amount of traffic, remoteness of site, and the cost of the emergency closure system. Such closures typically consist of a structure system stored immediately adjacent to the lock (such as bulkheads) and an onsite lifting system such as a pedestal crane, gantry crane, or stiff-leg derrick located on or adjacent to the lock wall. The system is designed and arranged to minimize time required to install the closure. Operating personnel must be able to install these structures in flowing water, and therefore the system requires special attention. If bulkheads are used, typically a lowering carriage will be installed in the bulkhead slot which allows the bulkhead stack to be lowered slowly. With this closure procedure, the flowing water does not pass over the bulkheads. Other emergency closures that have been used consist of the following:

(1) Hoist car traveling on overhead service bridge and handling the emergency bulkheads which are also used for the dam spillways.

(2) Submerged vertical lift gates with permanent operating machinery in the lock walls.

(3) Bulkheads or a single-leaf gate and operating machinery permanently located upstream of the upper service gate--mounted high enough to allow upper pool traffic to have proper overhead clearance.

5-9. Galleries and Cable Trenches

Galleries are sometimes used in lock structures to provide passage for mechanical and electrical lines across the lock or down the lock chamber walls to the lower gates. Typically, galleries crossing the lock are located in the upper gate bay sill if sill thicknesses will allow. This type of gallery can also provide emergency access to the river wall in the event access across the upper gates is lost. Where a gallery is not feasible, mechanical and electrical lines can pass along lock walls in cable trenches located in the top of the walls. These trenches are easy to reach and relatively easy to maintain and permit quick access to lines for maintenance as well. However, if the lock walls can be overtopped, cleanup could be a problem. These trenches are sized in accordance with the mechanical and electrical design of each individual lock. The trenches

should be covered with either open grating or steel plating and should allow for easy lifting or removal of the covers.

5-10. Lock Wall Accessories

a. Floating mooring bitts.

(1) Purpose. When tows have entered the lock chamber, some method is required to keep the barges under control and relatively stationary while the lock chamber is being filled or emptied. Floating mooring bitts attached by lines to the vessels will meet this requirement. Many improvements have been made in filling and emptying system designs in recent years, i.e., reduction of turbulence in the lock chamber and elimination of overfill and overempty situations by timely culvert valve operation. However, it is still necessary to use floating mooring bitts to keep barges and pleasure craft from drifting into the lock gates and bumping each other and to compensate for any human error in the filling and emptying process. It may also be necessary to use only one culvert for lock filling and emptying, in which case the turbulence in the lock chamber could result in greater forces on the vessels than that normally experienced.

(2) Locations. Four to eight floating mooring bitts are usually provided in each chamber wall, depending on the length of the lock chamber, with a variable spacing to fit tows of different size barges. Plate 38 shows suggested spacing for floating mooring bitts, as well as spacing for other lock accessories, for a 600-ft lock chamber. Generally, floating mooring bitts should be no closer than 30 ft from the upper gate or 75 ft from the lower gate in the mitered position, to help protect the gates from barge overtravel.

(3) Description. Floating mooring bitts with mooring posts consist of a watertight floating tank which rises and falls as the lock chamber water level raises and lowers. This floating tank is mounted with wheels which ride inside steel guides in the mooring bitt recesses. It is desirable to provide two mooring posts on each tank, spaced at levels to accommodate the height above water level of either loaded or empty barges. Usually a vertical spacing of about 6 to 8 ft for the two posts will be required. See paragraph 10-2 for design of floating mooring bitt components.

b. Line hooks. Line hooks are placed in the face of the lock chamber and approach walls whether or not floating mooring bitts are provided. These hooks are usually placed in a series, one directly above the other about 5 ft apart, starting a short distance above lower pool

level and ending near the top of wall or above maximum upper pool level. The spacing of the hooks along the lock walls is for the use of small boats or short tows when it is considered unnecessary for such vessels to pass lines to the top of walls for mooring. The boat operator in this case transfers the line to the next hook as the boat is raised or lowered. Although not directly related to floating mooring bitts, a vertical row of heavy line hooks for checking tows (to discourage checking on the bitts) should be provided at each bitt and at about 150-ft intervals outside the local chamber.

c. Ladders. Vertical ladders are necessary for access to and from the lock chamber. These ladders shall be placed at strategic locations for use in gaining access to the floating plant, as an aid in the rescue of accident victims, and for access to the lock floor during construction and maintenance operations. At least one ladder that leads directly to the lock floor should be located on each wall, and to provide access to both the upper and lower sills inside the unwatering closure structures. Ladders should be provided to low-water surfaces on both the upper and lower approach walls. Wall ladders should be spaced to ensure that a person falling into the water would not have to swim over 200 ft to a ladder. It is recommended that ladders be mounted in offset recesses.

d. Guardrail and parapets. Guardrails must be provided on both sides of gate and bridge walkways and for lock and approach walls when the backfill is a sufficient distance below the top. All waterside faces of walls shall have either guardrails or parapets for their entire length. Parapets about 2 ft high with indentations at each of the check posts may be provided in areas where snow and ice do not pose hazards. Removable guardrails consisting of posts and chain may be provided in cold climates. In addition, all stair wells, ladder recesses, and other openings at the top of walls and at other locations not protected with covers shall have guardrails or other protective equipment on all sides. Guardrail and other protective devices shall conform with the safety requirements contained in EM 385-1-1.

e. Safety jib crane. Fully rotating (360 deg) electrically operated jib cranes must be provided to store and efficiently handle the safety skiffs (16-ft boat) required by safety regulations. The skiffs should be located upstream on the upper approach wall and on the downstream guard wall. Cranes and associated appurtenances should be located to provide easy access to the skiff by means of permanent ladders or stairs, regardless of whether it is in the water or stored on the lock wall. Each of the two lifeboat locations should be equipped with half-ton jib

crane, a 16-ft aluminum lifeboat, and a 10-hp outboard motor. The specifications for jib cranes should include weatherproof motors and a hoist of industrial design, mounted on a suitable trolley which will allow travel up to 12 ft to permit precise spotting of boat. The entire jib crane should be constructed to allow one man to conduct complete operation and skiff launching procedures.

f. Distance markers and sill markers. Distance markers should be provided along the lock approach walls and lock chamber walls to provide tow operators with means to estimate their distance from the lock gates and gate sills. For the upstream approach walls, distance markers should begin with zero immediately upstream of the upper gate recess and should consist of a number indicating the distance in feet to zero. The numbers should be white on a green background. In the lock chamber, the markers should be located on each chamber wall. The left descending wall should contain distances to the upper gate sill marked every 100 ft. The lower approach wall marking should be similar to the upper wall, with distances measured from the lower gate.

5-11. Tow Haulage Unit and Movable Kevel

When a tow is longer than the lock chamber, it must be split and locked through in two sections with the towboat remaining with the second section. Some means must be provided to pull the first section out of the chamber so that the chamber can be prepared to lock the second section through. A number of types of haulage units have been used, and the type selected for a particular project will depend on the amount of use expected.

a. Types of tow haulage units.

(1) The simplest installation of a tow haulage unit is a pair of single-drum hoists, either electric or air-driven. One hoist is located on the top of the lock wall upstream from the upper gate bay, and the other similarly mounted downstream from the lower gate bay. The free end of the line is paid off the drum and fastened to a bitt on the back barge of the first section. The barges are then pulled out of the chamber and snubbed to check posts or line hooks until the second section is locked through. The tow haulage unit should always be on the guide wall side, and upstream and downstream approach walls (guide walls) must be located on the same side of the lock in order for the tow haulage unit to function properly.

(2) Another type unit consists of a single reversible hoist located at about the center of the lock and an endless cable running along the face of the lock wall and

around sheaves near the gate recesses. The single-hoist layout should always be used since the double-hoist arrangement with a single line is extremely dangerous to operating personnel. This cable (wire rope) is provided with a flexible fiber line long enough to reach pool level and is fastened to the back barge either directly or with an intermediate hawser. Barges are pulled out as described above. The hoist drum is designed so that as the cable (wire rope) is paid out at one end at bottom of the grooved drum, it returns onto the top of the drum at the same end. The length of the cable on the drum equals total travel plus two wraps. The most sophisticated system uses a reversible hoist and endless cable which pulls a wheeled towing bitt on the top of the wall between the gate bays. The bitt may travel in a recess provided for it, or it may be mounted on a rail fastened to the concrete. The latter is used for locks already constructed or in cold climates where snow and ice would clog the recessed type. A hawser (line) furnished by the tow is slipped over the traveling bitt and fastened to the back barge as before. It is very important that the lock operator be able

to see the barges that are being pulled during the entire operation. Therefore, the lock operator should operate the tow haulage unit from the lock wall opposite the tow haulage unit.

b. Movable (traveling) kevels. All tow haulage units should be furnished with two unpowered, movable kevels. One of these kevels should be located on the upstream guide wall, and one should be located on the downstream guide wall, just outside the main lock gates. The minimum length of travel of each of these kevels should be equal to the travel of the tow haulage unit. The length of travel for the tow haulage unit should be equal to the clear inside length of the lock chamber--the distance between downstream miter gate recess and upstream miter sill. The purpose of these unpowered traveling kevels is to hold the head of the tow into the guide walls as the haulage unit pulls the tow out of the lock chamber. An unpowered, power retrieved kevel can be provided to prevent a lockman from having to walk the length of the guide wall and return (retrieve) the kevel manually.

Chapter 6 Appurtenant Structures and Other Considerations

6-1. General

This chapter discusses elements of a navigation lock project that are not part of the actual lock structure. These elements include features such as the lock control house, control stations, access bridge, service bridge, operation and maintenance buildings, elevators, public access (including persons with disabilities), and lighting requirements. Plate 9 shows the location of several structures discussed in this chapter.

6-2. Lock Buildings

The types of buildings and their functions include the lock control house, lock control stations, administrative buildings, operation and maintenance buildings, and other buildings. The layout and design of these buildings should be developed through an interdisciplinary team effort involving the district lock operations personnel, architectural, and engineering design personnel. The lock buildings should be built for durability and minimum maintenance and should incorporate appropriate aesthetic treatment. The buildings should contain adequate space for electrical and mechanical equipment and should be constructed for noise reduction where necessary. The buildings should have heating and cooling capabilities consistent with their function. They should also have adequate lighting and potable and waste water treatment facilities. Also, the buildings should provide safe and adequate facilities for visitor access (including persons with disabilities as required by regulation) as well as the features needed for efficient lock operation. Among these features, designing for safety and fire resistance is of primary importance. The design for safety should comply with EM 385-1-1, and it should satisfy local ordinances. The local building codes will be used for fire and safety. Exceptions to local ordinances will normally require approval by higher authority.

a. Lock control house. The primary function of these enclosures is to provide shelter for the master controls and associated equipment used to operate the lock gates and the filling and emptying system. On almost all existing locks, these control enclosures are located on the lock walls next to the upstream lock gates. Moreover, for locks adjacent to navigation dams, it is advantageous to locate the lock so that the axis of the dam is in line with

the upstream lockage. The upstream location provides the best vantage point from which to visually monitor navigation traffic and conditions upstream of the dam. These locations are based on using site surveillance for control of lock operations. Some newer projects have incorporated the latest technology for surveillance and control by locating the routine controls remote from the lock wall. As the technology improves, even more flexibility for the location of control operations will be available. Two important design considerations are: to assure that the control house does not infringe on the space required for passage of tows, and to assure adequate visibility of locking operations, preferably with the lock operator seated behind the controls. The interdisciplinary team should plan the control house in the early phases of lock layout studies to ensure adequate coordination among operation and visitor access, lock operating equipment, aesthetic treatment, operating requirements, engineering, and other requirements. The operating equipment in the control house should be located above project design flood. If not so located, it should be designed to resist flood damage. Also, the design should provide an entranceway to the control house during the project design flood conditions.

b. Local control stations. In some older locks, a small building or enclosure located next to the upstream gate and/or the downstream gate contains controls for the gates and the filling and emptying valves. Thus, these older locks are operated from the controls nearest to the gate being operated. This location allows the operator to view both the upstream and downstream sides of the gate before it is opened or closed to assure that no accidents will result from the gates obscuring small boats from view. With modern surveillance technology, control stations other than the control house will be necessary only for emergency conditions and for gate maintenance. The control stations on the lock walls can be fixed structures or can be portable to permit removal before flooding conditions. Normally, provisions for heating, air conditioning, and plumbing will be minimal in the control stations, consistent with the amount of time an operator is required to stay in the station.

c. Operation and maintenance buildings. These buildings are normally located onsite, separate from the lock structure. Visitor reception, lockmaster offices, and administrative offices are included in the operations building.

d. Paint, oil, and lube storage. An area is also needed to accommodate storage of paint, oil, and

lubricants if the lock is remote from a suitable existing facility. To satisfy aesthetic purposes and fire codes, these buildings are separated from the lock and other site buildings.

e. Water treatment plant, waste water treatment, and disposal systems. Onsite, separate housing is required for these functions when local utility systems are not available. Housing for these systems should be screened from public view or should be designed with aesthetically pleasing exteriors.

f. Emergency generator building. Frequently, an emergency generator is provided at the lock and will require housing either in the control house or at some distance from the lock structure.

6-3. Esplanade

An esplanade is an area adjacent to the lock where the various buildings, staging areas, and parking facilities are located. Frequently, backfill is placed on the landside of the lock to form the esplanade. This esplanade also provides easy access to the lock for maintenance. Ideally, the esplanade surface should coincide with the top of the lock wall. However, the elevation of the esplanade should be high enough to prevent undesirable sediment and debris deposits during flooding. The upstream and downstream limits of the esplanade will be determined by the slope requirements and the geometry of the lock. In some of the newer locks, an extensive operation and maintenance complex and visitor facilities were not considered essential. In these cases, hydraulic, structural, navigation, and sedimentation concerns led to the decision to use a reduced esplanade. The presence of esplanades affects the soil loads imparted to the lock structure. The backfill should contain freely draining material complete with collector pipe and filter to maintain the backfill saturation at a level near that of the lower pool. The freely draining material should be capped with impervious material to minimize saturation from the esplanade surface. A vertical impervious zone should be provided adjacent to the upstream lock gate to minimize seepage of the upper pool into the freely draining material.

6-4. Access Bridge

The most cost-effective access to the lock wall is via the earth fill esplanade. However, sometimes a bridge is the only alternative. Vehicles and pedestrians can reach the lock by the same roadway or bridge. However, control of visitor access and safety may justify providing two bridges.

a. Pedestrian. A pedestrian bridge can be constructed on top of cutoff walls (floodwalls connecting the lock to high ground). These bridges will probably be used to carry heavy tools and equipment to the lock, as well as for pedestrian access, and should be designed accordingly.

b. Vehicle. This access bridge will probably require a pier substructure and foundation. If piles are exposed to the atmosphere and to a fluctuating water surface above ground, consideration should be given to using concrete piling instead of steel piling for bridge support. Whether vehicle access is by land or by bridge, the design should provide for adequate turnaround and parking facilities by the lock. Bridges should be designed for a minimum load of HS20 as specified in American Association of State Highway and Transportation Officials (AASHTO) Standard Specifications for Highway Bridges. Careful consideration should be given to the bridge design loadings, particularly if cranes or other heavy off-road equipment will use the bridge for access to the lock.

6-5. Emergency Access

In planning the lock layout, a strategy should be developed for access between opposite sides of the lock during flooding or with loss of the lock gates. Usually, a highway bridge will cross the waterway within proximity of the lock and will be adequate for such access. Frequently, galleries, which cross the lock through the gate sill, provide a means of emergency access. If no other access alternative is feasible, then access will be by boat. In addition, a means should be provided to enter the lock control house whenever the normal entrance is not available due to flooding conditions.

6-6. Service Bridge

A service bridge provides access between piers on a navigation dam and occasionally for elevated access across the lock. Usually, the primary purpose of the bridge is pedestrian access to the various structural features for project operation and maintenance personnel. In some cases, the service bridge has multiple purposes such as to transport and install emergency bulkheads with hoist cars or gantry cranes as well as to provide for crew access. The service bridge can also serve as a public road and provide support for utility lines when appropriate. Coast Guard regulations define the vertical navigation clearance a service bridge must have when spanning a lock chamber. The structural design for the bridge should correspond to the purposes of the bridge as required in the AASHTO or

American Railway Engineering Association (AREA) standards.

6-7. Public Access, Observation Platforms, and Visitor Centers

Facilities should be provided to accommodate visitors during lock construction as well as during lock operations after construction is completed. In the development of these facilities, the safety of the visitor should be a major consideration. Consideration should be given to using observation platforms during construction. If the lock is located in or near a metropolitan area, then the lock design should accommodate public viewing of the locking procedures and a description of the lock operations in the visitor center.

6-8. Provisions for the Disabled

Facilities must provide appropriate access for employees and visitors with disabilities, per current regulations.

6-9. Elevators

The use of an elevator should be limited to those projects in which it is necessary to accommodate visitors and persons with disabilities or to access the control house operating floor or the adjacent dam pier when either is elevated considerably above the lock wall. However, the primary means of vertical transport of freight should be by means of the crane provided at the lock.

6-10. Lock Lighting

Modern locks are designed with high mast lighting which provides the illumination necessary for navigating the lock at night. The design of the high mast lighting should provide an adequate level of resistance to wind induced vibrations. Additional lighting requirements on a lock include mooring bitt recesses and navigation guard and traffic control lights. The standards that apply to lock lighting are discussed in ER 1130-2-306.

Chapter 7 Gates, Valves, and Bulkheads

7-1. General

This chapter provides a discussion of the various types of lock gates, valves, and bulkheads. The discussion includes advantages and disadvantages, geometry, and recommendations for application of different types.

7-2. Lock Gates

The primary function of lock service gates is to form a damming surface across the lock chamber. Depending on the specific type gate and the conditions at a particular project, lock gates can be used to fill and empty the lock chamber and to pass ice and debris. These gates can also be used to unwater the lock chamber and to provide access from one lock wall to the other by means of walkways or bridgeways installed on top of the gates. For further descriptions and details on lock gates, including cathodic protection and painting requirements, see EM 1110-2-2703. Seven different types of gate structures have been used in the past for lock service gates. These structures include the following: miter gates, submergible vertical lift gates, overhead vertical lift gates, submergible tainter gate, vertical axis sector gates, rolling gates, and tumbler gates. The horizontally framed miter gate has proven to be the best type lock gate based on operational efficiency and lower maintenance requirements. However, use of the submergible vertical lift gate, the overhead vertical lift gate, the submergible tainter gate, or the sector gate may be advisable because of specific project conditions and requirements. Because of recent technological advances, the rolling gate and the tumbler gate will probably not be used on future locks.

a. Miter gates. A miter gate has two leaves that provide a closure at one end of the lock. The miter gate derives its name from the fact that the two leaves meet at an angle pointing upstream to resemble a miter joint. Horizontally framed miter gates have many advantages over other gate types and have been used on more locks than any other type gate. Miter gates are rugged and do not involve complicated construction problems. Miter gates are also easily serviced and fast operating. The only drawbacks arise from the inability of the gates to operate under head and to withstand reverse head. Plate 6 illustrates a miter gate installation.

b. Lift gates.

(1) Submergible vertical lift gates. Submergible vertical lift gates can be used at the upstream end of a lock. If the lift is high enough, a single-leaf gate can be designed so that when it is lowered, it drops down along the downstream face of the sill block. If the lift is not as great as the upstream sill depth, the gate may have separate sections side-by-side that are raised and lowered individually. However, it is not recommended to use a submergible vertical lift gate in a situation where the leaf or leaves would have to rest on the bottom of the lock chamber or in a bottom recess when the gate is lowered. Debris and silt would cause operation problems and lead to high maintenance costs. A vertical lift gate can be designed to operate under either direct head or reverse head. The disadvantages of the vertical lift gate are high maintenance and operation costs and difficulty in controlling skew and misalignment. Plate 37 depicts a single-leaf vertical lift gate, and Plate 35 shows a submergible double-leaf vertical lift gate.

(2) Overhead vertical lift gates. The overhead vertical lift gate has been used as the downstream gate at several locks where the lift is great enough to provide sufficient overhead clearance when the gate is in the raised position. For example, this type gate has been used at the downstream end of the John Day, Ice Harbor, and Lower Monumental Locks. Overhead lift gates at these locks are rugged and heavy. They have the same general advantages as the submergible lift gates but require a much longer operation time--approximately 3 to 5 min. This type of vertical lift gate requires counterweight. Operation and maintenance problems are not as great with overhead lift gates as with submergible gates. Plate 37 shows an overhead vertical lift gate.

c. Submergible tainter gates. Submergible tainter gates have the same advantages as submergible lift gates, but they are subject to the same limitations with regard to their use in a low- or medium-lift situation. The lift must be great enough to allow the gate to submerge to below the sill without resting directly on the lock floor. Submergible tainter gates also have fewer operating and maintenance problems than vertical lift gates. However, if traffic is heavy, the longer operating time required for the tainter gate type closure can be a disadvantage. A submergible lock tainter gate is shown on Plates 7 and 36.

d. Vertical axis sector gates. A vertical axis sector gate, similar to a miter gate, requires two sections for closure of a lock chamber. Plates 13 and 14 show a sector gate installation. The two sector gate sections are used in pairs and are designed to rotate around a vertical axis and meet at the center line of the lock chamber. Since the hydrostatic pressure is toward the gate axis, there is very little unbalanced hydraulic force opposing opening or closing of the gate under any condition of head. Since sector gates can be opened or closed under a head, they can be used for filling and emptying locks with very low lifts. Sector gates can be designed to withstand head from either direction and are very useful at a tidal lock or at any situation where reversal of head occurs. The two principal disadvantages of sector gates are their cost and the amount of horizontal space they require.

7-3. Culvert Valves

Lock filling and emptying systems that have culverts in the lock walls require mechanically operated valves to control the flow of water into and out of the lock chamber. These valves are located in the culverts near the upstream and downstream ends of the lock chamber and are usually of the same height and width as the culvert. Two valves are required in each longitudinal culvert. One valve is located between the intake and lock chamber to admit the water in the filling operation, and the other between the chamber and the discharge diffuser to empty the lock chamber. A typical valve layout in a lock wall is shown in Plate 6. Further information on lock culvert valves can be found in EM 1110-2-1604 and EM 1110-2-1610.

a. Types of lock culvert valves. The different types of valves used in the past for controlling the flow of water into and out of the lock chamber include the following: reverse tainter valve, true tainter valve, stoney valve (vertical slide valve), butterfly valve, wagon valve (wheeled vertical lift valve), spool valve, and cylindrical valve.

b. Background. Currently, all medium- to high-lift major locks under construction use the reverse tainter valve. When the true tainter orientation was first used in the 1930's, the skin plate was located upstream with the supporting arms in compression. But this arrangement allowed large amounts of air to be drawn into the culverts from the valve shaft, and the air became trapped into the flowing water which hindered the water flow. When enough pressure developed, the water would enter the lock chamber and cause extreme disturbances in the downstream valve shaft and to small craft and moored

vessels in the chamber. However, subsequent model tests of the reverse tainter valve with the skin plate downstream and the valve arms in tension showed that this arrangement prevented air from entering the culvert at the valve shaft, and thereby the entrapped air problem was solved. However, it was several years before the best results were obtained with a single skin plate vertically framed body. Many shapes of the valve body, such as double skin plates with both plates convex, double skin plates with concentric skin plates, using both covered support arms and arms with no special treatment, were model tested and built before the single skin plate vertically framed layout was finally adopted as the best arrangement.

c. Guidance. Structural stainless steel side seal guides must be furnished above the top level of the culvert, so that the valve is laterally supported and thus maintains its stability throughout its entire range of travel from the culvert floor to the fully open position. Selecting the proper type of rubber side seals and the top seal for culvert valves is important. The rubber seal should have teflon coating. The coating greatly reduces contact friction on the rubbing plates during valve movement. A "J" seal properly oriented, positioned, and adjusted has been found to be the most suitable choice for use as side seals. The top seal may be either a block type or a "J" seal.

d. Maintenance bulkheads for culvert valves. Culvert bulkhead recesses, which extend from the top of the lock wall to the floor of the culvert are provided immediately upstream and downstream of each culvert valve shaft. This arrangement allows bulkheads to be lowered to the floor of the culvert for unwatering of the individual valve shaft for culvert valve inspection and repair without the necessity of shutting down the entire lock. In this case, the lock chamber can be filled and emptied through the other culvert at a reduced rate of speed. Also, during lock unwatering, the two extreme upstream and downstream bulkheads are put in place so that all four valves may be inspected and serviced. Usually, the culvert bulkheads are stored on hangers at the top of the recesses for easy access in case of valve failure. At least four bulkheads must be provided so that the entire lock chamber can be unwatered. Bulkheads may be constructed of structural steel, high-strength low alloy steel, or aluminum, and may be one piece or sectional. Sectional bulkheads are especially adaptable when a mobile crane with limited lifting capacity is provided at the lock. The bulkheads should be designed for the hydrostatic head from the maximum anticipated upper pool level to the culvert floor. These bulkheads are designed neither to be

lowered to the culvert floor in flowing water nor to be removed when an unbalanced head exists. Therefore, some means must be provided for bypassing the bulkheads and filling the valve shaft so that the bulkheads may be removed under balanced head. Recesses downstream from the filling valves are often equipped with horizontal sealing diaphragms just above normal lower pool to prevent air from being sucked into the culvert during the lock-filling operations. The diaphragms must be removable for placement of the bulkhead when needed.

7-4. Lock Chamber Bulkhead Closures

In addition to the normal operating (service) gates, all locks should have temporary closures for unwatering the lock chamber during maintenance activities. These closure structures can be stored either at the site or at a

central location if used for several locks. Installation can involve the use of cranes, stiffleg derricks, derrick boats, and divers. Maintenance closure structure types include sectional bulkheads, poiree dams, needle dams, and floating caissons which are installed in a static (balanced) pool. Some locks need to have upstream emergency closures bulkheads which can be used to stop the flow of water through a lock chamber. These bulkheads are used in cases in which flow through the lock is allowed during open-river conditions or the service gates should fail to operate properly or be damaged by traffic so they will not close. Emergency closure structure types include stacked sectional bulkheads and vertical lift gates (overhead or submerged) which can be installed in flowing water. Figure 5-2 shows a typical installation of bulkheads that can be used for either maintenance or emergency procedures.

Chapter 8 Loads

8-1. General

The chapter contains discussion and guidance on loads that can normally be expected to be imparted to a lock or any appurtenant structure. This discussion includes live loads due to hydraulic forces, impact, seismic and ice forces, earth pressures, and thermal stresses. Dead loads include weight of the structure and equipment.

8-2. Hydrostatic

For hydrostatic loads, the damming action of a lock must be effected at both the upper and lower gates. The water pressure against the face of the lock walls and the base slab is variable and depends on the waterway stages that prevail at a particular time or on other water conditions which may produce higher pressures. For those elements of a lock that are not required to resist lateral earth thrusts in conjunction with water pressures, the maximum pressures are easily determined. However, most lock locations have backfill adjacent to least one wall.

a. Horizontal water pressures. No definite rule can be followed in determining the level of the groundwater in the backfill adjacent to the back face of a lock wall. However, it is well established that the saturation level varies between the upper and lower pool elevations, and the degree of variation depends on the physical characteristics of the backfill material and the permeability of the foundation. The location of the saturation line should be determined analytically, based upon laboratory tests of the dry and wet characteristics of the soils, the extent of compaction to be used, and the effect of local climatic conditions.

(1) A majority of the navigation locks in the United States are located in natural waterways where the backfill material has granular characteristics. This material has a tendency to drain and to become saturated with an approximately straight-line variation between pool elevations. For projects with fairly stable pool levels, these assumptions should be sufficiently accurate to give satisfactory results. However, varying pool levels and use of impervious backfill material will probably cause considerable departure from straight-line variation. For lock installations with a lower pool subject to greater fluctuations than the upper pool, a lower pool stage that is exceeded not more than a small part of the time should be selected from the stage duration curves. In this case, the

saturation line can be constructed between this lower pool level and the normal upper pool level, and the height of the groundwater table can be determined accordingly for that portion of wall under consideration. The extent of saturated earth must be established with a reasonable degree of accuracy in order to accurately represent horizontal force due to earth and water pressures and uplift.

(2) In addition to the usual stabilized groundwater levels caused by normal discharges, extreme loading conditions due to raised saturation levels must also be investigated. These conditions include the effect caused by locally heavy rains without an accompanying rise in the pool stages and by flood discharges that overtop the walls which cause the earth to become saturated throughout. Following flood discharges, the pool levels often approach their normal levels more rapidly than the fill material can drain. Although these increased loads are serious and should be investigated, the stability requirements are usually relaxed because of their short duration and the infrequent occurrence of such increased loads. For this condition, the assumption is often made to raise the saturation line above its normal location to one-half the distance to the top of the fill. The remainder of the fill is considered as moist earth. An effective method of controlling the saturation line is to provide a collector pipe surrounded by a properly designed filter material at some convenient level above the lower pool. This method can consequently reduce the water pressure against the wall in a free-draining material. To create an effective system, an impervious zone must be placed at the upper end of the lock wall extending to the natural bankline or to some other adjacent structure. This system will form an effective damming surface and retard flow of the upper pool groundwater to the lower pool through the fill material. This type of design not only effectively lowers the saturation line for the normal operating conditions but also will facilitate drainage of the backfill immediately after the extreme loading conditions.

b. Uplift. The problem of uplift for lock walls is complicated by fluctuating water levels within a lock chamber. The rate of change of uplift as the chamber is filled or emptied is not known.

(1) Rock foundations.

(a) Upper pool in lock chamber. For the river wall, uplift will vary from 100 percent of lower pool at the riverward face to 100 percent of upper pool at the chamber face. For the land wall, uplift will vary from 100 percent of the head represented by the saturation level

in the backfill at the landward face to 100 percent of upper pool head at the chamber face.

(b) Lower pool in lock chamber. For the river wall, a uniform uplift of 100 percent of lower pool head will exist under the entire base. For the land wall, uplift will vary from 100 percent of the head represented by the saturation level in the backfill at the landward face to 100 percent of lower pool head at the chamber face.

(c) Maintenance. For the river wall, uplift will vary from 100 percent of lower pool head at the riverward face to a head represented by the pumped down level at the chamber face. For the land wall, uplift will vary from the saturation level at the landward face to the pumped down level at the chamber face.

(d) Construction. Uplift acting on the base of any monoliths within the cofferdam is assumed to be zero.

(e) Drainage. In cases where adequate drainage (relieving to tailwater) is provided near the chamber face, total uplift may be reduced for the condition of upper pool in the lock chamber. For river walls, uplift will vary from 100 percent of tailwater plus 50 percent of the difference between headwater and tailwater at the chamber face to 100 percent of tailwater at the river face. For land walls, use the saturation line instead of tailwater. Probably the most effective land wall drainage is that provided in the backfill to reduce the saturation level.

(2) Soil and pile foundations. Monoliths on soil or pile foundations usually have cutoff walls and sometimes have drainage systems. At one face of the monolith, uplift should be the full headwater pressure from the face of the wall to the cutoff. At the other face, uplift equals the full tailwater pressure (or the saturation head in the backfill). Uplift pressures between these points should be determined by evaluations of cutoff and drain effectiveness and soil permeability. Cutoffs and drains will provide at least a 50 percent reduction in uplift, similar to rock foundations. Under ideal conditions, cutoffs and drains can be considered 100 percent effective in reducing uplift pressures.

(3) Seepage paths. The uplift under U-frame locks is complicated by alternative seepage paths along and perpendicular to the lock axis. The permeability of the foundation soils, as well as the existence of sheet pile cutoff walls and foundation drains, affect the variation of the uplift pressure. Close coordination with geotechnical engineers is needed to determine the uplift pressure for each lock monolith. All combinations of operating and

maintenance conditions should be analyzed to determine the most critical condition.

(4) Uplift. Except for earthquake loading, any portion of the base, not in compression, will be assumed to sustain a uniform uplift equivalent to 100 percent of the adjacent pool or saturation level. Uplift for loading which includes earthquake will be assumed to be equal to that for the same loading without earthquake.

(5) Internal stresses. Because minor movements of gate sills affect the gate operations, all sill blocks should be analyzed for stability and for internal stresses resulting from maximum differential heads. Uplift on the base and hydrostatic internal pressures will be assumed to vary from 100 percent of high-water pressure to 100 percent of low-water pressure. Any portion of the base or horizontal internal plane not in compression should have a uniform uplift of 100 percent of the high-water head acting upon it.

8-3. Earth Loads

In lock wall design, careful investigation of available backfill materials and methods of backfilling is of primary importance.

a. Horizontal earth pressures. Generally, "at-rest" pressures should be used for gravity sections on rock foundations. Few rock foundations yield enough to develop active pressure values. Values for these pressures should be determined for the various conditions of the backfill (drained, saturated, or submerged) by accepted soil analysis methods. Horizontal earth pressures below assumed saturated levels will be computed at the same horizontal earth pressure coefficient used for the drained or saturated condition. At-rest pressures should be used for other foundation types unless sufficient movement is expected to result in active soil pressures.

b. Silt. Model studies can only indicate tendencies for location of silt accumulations. If the model studies indicate tendencies for silt buildup, the most conservative assumptions for depth of silt should be used, and corresponding vertical and horizontal loads should be used in the analysis.

c. Vertical shear (downdrag). Walls (lock walls, approach walls, miscellaneous walls) that retain fill should consider vertical shear in the stability analysis and in the slab design in the case of a U-frame or W-frame. The vertical shear is a result of a change in the state of stress

in the soil backfill as vertical loading changes. These changes occur during initial construction (backfill is consolidating) or during unwatering of a U-frame or W-frame (the lock wall is tending to move up with respect to the stationary backfill). The computational procedure for computing the vertical shear is to use a vertical shear coefficient K_v applied to the effective vertical stress of the soil. The vertical shear is then applied at a plane extended at the outermost extremity of the wall.

8-4. Earthquake or Seismic

Two general approaches to determining seismic forces include the seismic coefficient method and a dynamic analysis procedure. The seismic coefficient method (also known as the pseudostatic method) should be used only as a preliminary means to determine the location of resultant and sliding stability of lock monoliths, or to analyze gravity lock walls at horizontal sections to determine if the horizontal section is in 100 percent compression. If the seismic loads computed by the seismic coefficient method indicate a problem, a more rigorous dynamic analysis should be performed as described in Chapter 10. Seismic coefficients are based on the seismic zones provided in ER 1110-2-1806. Details of this procedure are contained in EM 1110-2-2200.

8-5. Impact

Tows operating on inland waterways can lose control and collide with lock walls. The design of navigation lock approaches is influenced to a great extent by impact loads from collisions. The magnitude of the impact forces depends on the mass including the hydrodynamic added mass of the barge tow, the approach velocity, the approach angle, the barge tow moment of inertia, damage sustained by the barge structure, friction between the barge and wall, and the flexibility of the approach wall. An analytic method which can be used to approximate the maximum impact forces on structures located in navigable waterways is presented in ETL 1110-2-338.

8-6. Hawser Loads

Hawser loads are generated by barges checking their movement into a lock by tying-off to a line hook or check post, or by loads imparted from movement perpendicular to a lock wall as a result of turbulence caused by filling or emptying the lock chamber. Since the filling and emptying system is generally designed so that the hawser

pull is limited to 10 kips, the controlling load will be the checking hawser pull.

a. Lock wall. The lock wall concrete should be designed for the parting strength of the strongest hawser anticipated to be used in the navigation system. Currently, the recommended hawser pull is 160 kips. The location of the load should be either 5 ft above the waterline or 1 ft above the lock wall (whichever is closest to the waterline). The angle of the load application should be consistent with a barge entering a lock and checking its forward movement by tying-off to a line hook or check post. Unless demonstrated otherwise, an angle of application of 30 deg with the wall should be used; therefore, the perpendicular component is 80 kips.

b. Line hooks, check posts, and floating mooring bitts. A hawser pull of 160 kips should be used for the design of line hooks, check posts, and floating mooring bitts and their anchorages.

8-7. Ice and Debris

Usually lock designs do not include the effects of ice loads on lock walls. However, approach walls, particularly those located in the upper approach, are sometimes subjected to moving ice and floating debris, and the wall designs should account for these effects. For projects where ice conditions are severe and where the ice sheet is short or can be restrained or wedged between structures, its magnitude should be estimated with consideration given to the locality and available records of ice conditions. A unit pressure of not more than 5,000 lb/sq ft applied to the contact surface of the structure at normal pool level is recommended. In the contiguous United States, the ice thickness assumed for design normally will not exceed 2 ft resulting in a design load of 10,000 lb/ft. However, a minimum load of 5,000 lb/ft is recommended to account for ice and debris. Further discussion on types of ice-structure interaction and methods for computing ice forces is provided in EM 1110-2-1612.

8-8. Wave Pressure

While wave pressures are of more importance in their effect upon gates and appurtenances, they may, in some instances, have an appreciable effect upon the lock or approach walls. Wave dimensions and forces depend on the extent of water surface or fetch, the wind velocity and duration, and other factors. Information relating to waves and wave pressures are presented in SPM (1984).

8-9. Wind Loads

Wind loads usually need not be included in the wall analysis, except where major portions of the walls are not backfilled, or where projections such as bridge piers and spans or control houses extend above their tops. If the design includes wind forces, the forces should be placed in the most unfavorable direction and should be assumed at 30 lb/sq ft unless past records indicate that other assumptions are warranted. TM 5-809-1 contains additional guidance on wind loading.

8-10. Gate Loads and Bulkhead Loads

a. Miter gates.

(1) Figure 8-1 shows the gate orientation and methods of determining the total thrust as applied to the wall for normal operating conditions.

(2) For horizontally framed gates, all of the water loads cause gate thrust which is transmitted through the girders and quoin blocking into the gate monolith. None of the load is carried into the sill beam. For vertically framed miter gates, part of the gate water load (R_1) is carried by a top girder of the gate and transmitted by it to the wall; the other part (R_2) is carried directly to the sill. The thrust of a vertically framed gate applied to the wall at the center line of the top girder is the same as for a horizontally framed gate except that P is substituted by R_1 .

(3) The gate dead loads may have a more severe overturning effect on the gravity lock walls when there is no water load on the gates. To obtain the maximum overturning effect, the gate leaves are considered to be swinging free in approximately the mitered position.

b. *Other gates and bulkheads.* Gate reactions from dead loads and hydrostatic loads must be considered during stability analysis and detailed design of all gate monoliths.

8-11. Crane, Equipment, Machinery, and Appurtenant Items

Loads due to machinery and appurtenant items are normally small but should be included when present. These loads may result from items such as miter gate operating machinery, tainter valve operating machinery, emergency bulkhead lowering carriage machinery, emergency cranes for placement of stoplogs, or stoplogs stacked in either

their storage location or the stoplog slots in the lock walls. These loads should be applied as point loads at the appropriate locations on the lock walls.

8-12. Cofferdam Tie-in Load

Cofferdam tie-in loads are caused by either cellular or embankment cofferdams constructed for a phase subsequent to the lock construction by using the lock structure as a portion of the dewatering cofferdam. These loads must be accounted for in the design, but they are normally considered an unusual condition.

8-13. Sheet Pile Cutoff Loads

Differential water pressure may exist on opposite sides of sheet pile cutoffs attached to the bottom of the lock monolith (see Plate 41). Past analyses have shown that the load on the monolith from this condition is small and can usually be neglected.

8-14. Monolith Joint Loads

Loadings in the upstream-downstream direction should be evaluated based on the critical condition of waterstops being ruptured or intact to give the greatest driving load. Typical waterstop details are shown on Plate 42.

8-15. Superstructure and Bridge Loads

Superstructure loads are defined as loads imparted to the lock walls as a result of structures such as the control house, electrical control structure, and any other enclosures needed for lock operation. Bridge loads are imparted to the lock wall as a result of piers that support a service, access, pedestrian, or highway bridge. Superstructure or bridge loads should be considered in the stability computations as well as for determining localized stresses in the concrete lock wall.

8-16. Temperature

a. A major concern in concrete lock construction is how to control cracking that results from temperature change. During the hydration process, the temperature rises because of the hydration of cement. The edges of the monolith release heat faster than the interior; thus, the core will be in compression and the edges in tension. When the strength of the concrete is exceeded, cracks will appear on the surface. When the monolith starts cooling, the contraction of the concrete is restrained by the foundation or concrete layers that have already cooled and

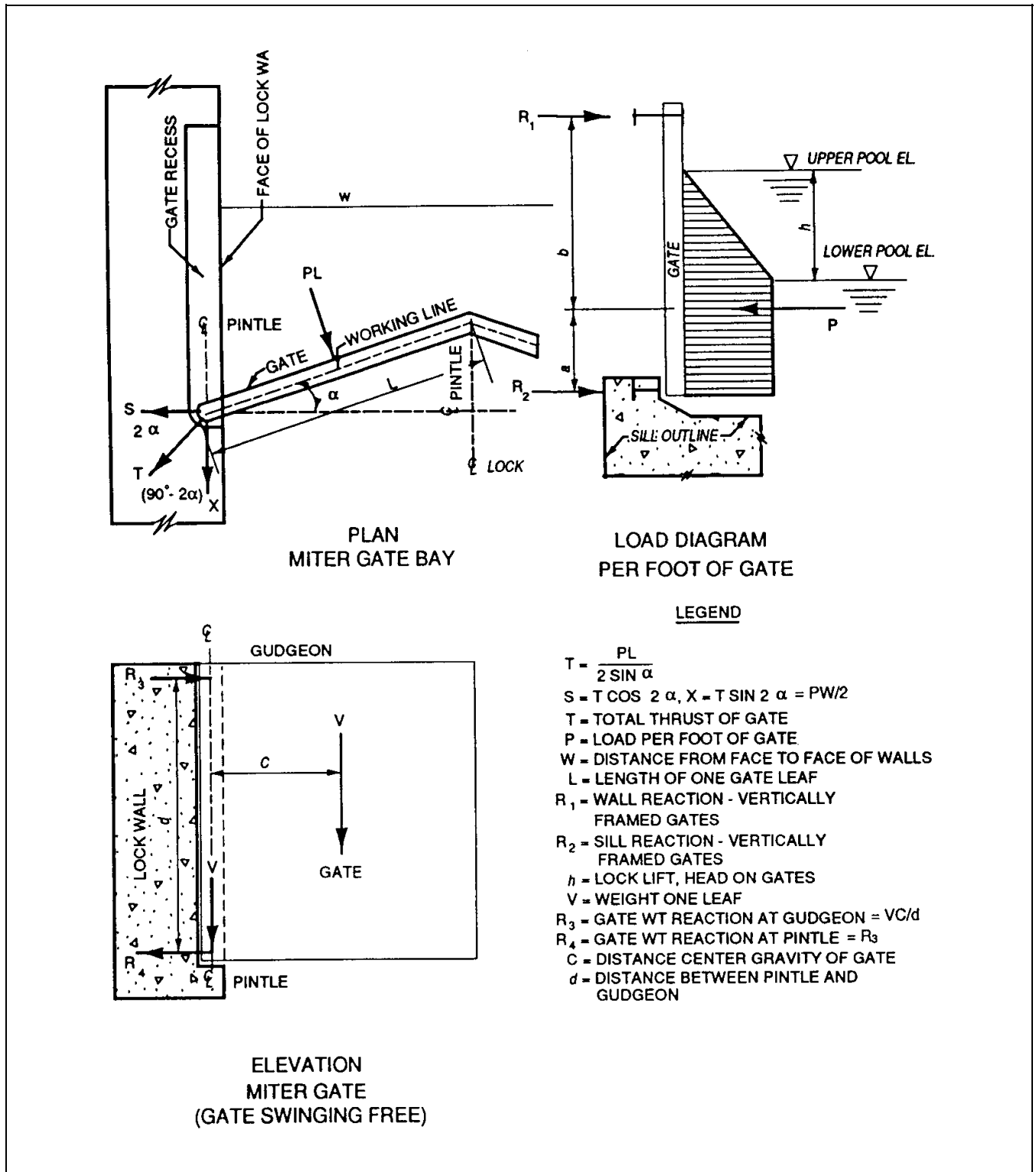

Figure 8-1. Miter gate, wall, and sill loads

hardened. Again, if this tensile strain exceeds the capacity of the concrete, cracks will propagate completely through the monolith. Cracking affects the watertightness, durability, appearance, and stresses throughout the structure and may lead to undesirable crack propagation which impairs structural safety.

b. Various techniques have been developed to reduce the potential for temperature cracking in mass concrete (ACI 224 R-80, ETL 1110-2-365). Besides contraction joints, these methods include temperature control measures during construction, cements and pozzolan for limiting heat of hydration, and mix designs with increased tensile strain capacity.

8-17. Hydrodynamic Loads

Hydrodynamic loads on lock walls may exist when the lock is constructed adjacent to the navigation dam. In this case, the outside of the lock is exposed to the turbulence of the water being discharged from the dam. The high-velocity flows and fluctuating water surface due to the dissipation of energy in the hydraulic jump cause low-frequency pressure fluctuations that should be considered in the design of the lock walls. The frequency,

magnitude, and areal extent of the pressures is site-specific and can be determined only by close coordination with hydraulic engineers.

8-18. Cyclic Loads

The nature of loads is cyclic due to the purpose of the project (raise and lower the water level in the lock chamber many times daily). Any components of the lock which are sensitive to cyclic loading should include the effects of these loads. Examples of components sensitive to cyclic loading include pile foundation design and reduction of design stress in steel and welded connections.

8-19. Internal Hydrostatic Pore Pressure in Concrete

Hydrostatic pressures within the body of the lock wall should be assumed to vary from 100 percent of tailwater at the low-water face to 100 percent of tailwater plus 50 percent of the difference between headwater and tailwater at the high-water face. The resulting force acting on a cross section will reduce the axial compression (or increase the axial tension) and should be considered in the stress analysis when it is conservative to do so.

Chapter 9 Analysis and Design Criteria

9-1. Stability Analysis

Each lock monolith must be designed to resist movement caused by applied loads. Such movement could include settlement, flotation, sliding, or overturning. Criteria for stability design is contained in EM 1110-2-2200 and in other guidance publications. If stability requirements cannot be satisfied, a pile foundation may be used. Criteria for design of pile foundations are contained in EM 1110-2-2906.

9-2. Structural Analysis

a. General. Analysis and design methods for U-frame lock monoliths are presented in ETL 1110-2-355. Many of these concepts are also applicable to other types of lock monoliths.

b. Two-dimensional (2-D) analysis. An analysis of a 2-D slice through a monolith can reliably represent the behavior of the monolith under the following conditions:

(1) When the cross-section geometry of the structure, the soil and water conditions, the support conditions, and the other loading effects are constant throughout an extended length of the monolith.

(2) When a 2-D slice, obtained by passing parallel planes perpendicular to the longitudinal axis of the monolith, typifies adjacent slices and is sufficiently remote from any discontinuities in geometry and loading (i.e., the slice is in a state of plane strain).

c. Two-dimensional frame analysis. Structural analysis of the lock is based on the assumption that the various slabs, walls, etc., of the structure interact as elements of a 2-D frame. The parts of the structure act as flexible members connected at their ends to joints. However, because of the thickness of some lock elements, the large joint regions reduce member flexibility. Representation of these rigid joint regions is discussed in ETL 1110-2-355.

d. Three-dimensional (3-D) analysis. If the lock monolith geometry and/or loading does not meet the above requirements for a 2-D frame analysis, a 3-D finite element computer model should be used to analyze the monolith. Guidance on modeling of structure for linear

elastic finite element analysis is provided in other Corps documents.

e. Seismic. Earthquake-induced ground motion effects must be considered in the analysis and design of navigation lock structures. The structures must be designed for the inertial forces from the structure mass combined with hydrodynamic pressures generated by the water inside and outside the lock chamber and within the culverts. These forces should be combined with any dynamic soil pressures generated within the backfill. Linearly elastic procedures used in design include the response spectrum analysis and the time history analysis.

(1) Seismic coefficient method. Traditional design practice based on the seismic coefficient method failed to account for the dynamic response characteristics of the soil-structure water system. Locks designed by the seismic coefficient methods may not be adequately proportioned or reinforced to resist forces generated during a major earthquake. Therefore, this approach should be used only as a simple, preliminary means of checking a new design or an existing structure for seismic susceptibility. It should not be used as a final analysis procedure for controlling member proportions or for remedial design (with the exception of those cases where extensive results or comparisons of previously designed or evaluated structures are available).

(2) Response spectrum analysis. A response spectrum is a plot of the maximum response of a series of single-degree-of-freedom (SDOF) systems with varying periods or frequencies. A response spectrum analysis partially accounts for the dynamic structural properties of the system. The response spectrum analysis can be accomplished by either a finite element or frame analysis. Results from these procedures provide only the *absolute* maximum stresses and forces due to the methods of combining modal responses.

(3) Time history analysis. The exact time history of a response quantity can be produced using this technique; therefore, an exact sign dependent stress distribution can be found at any given time. However, a digitized design earthquake record for the site is needed, and a significant computing effort is required for the numerical integration of the differential equation of motion using small time steps.

f. NISA. A nonlinear incremental structural analysis (NISA) should be done on massive concrete structures. This analysis should be performed if it will help achieve

cost savings, develop more reliable designs for structures that have exhibited unsatisfactory behavior in the past, or predict behavior in structures for which a precedent has not been set. A NISA first requires that a time-dependent heat transfer analysis be performed. The results of the heat transfer analysis are then used in a time-dependent stress analysis that simulates the incremental construction of the structure and uses nonlinear properties for modulus of elasticity, creep, and shrinkage. For more information on performing a NISA, refer to ETL 1110-2-365.

g. Load transfer between monoliths. Lock monoliths should be designed to act independent of adjacent monoliths. Only when all other means fail should load transfer between monoliths be considered. However, when it is necessary to design adjacent foundations as interacting to resist large lateral loads, the monolith joint details must be designed to ensure proper load transfer. The primary area for load transfer should be the base slab and not the lock walls. Provisions should be included for keying and grouting the monolith joints between the base slabs of interacting monoliths. The wall joints should be detailed to accommodate monolith movements without significant load transfer in order to control localized cracking and spalling. Base slab displacements should also be extrapolated to the top of the monolith to make sure that the displaced structure does not make contact with the adjacent monolith.

h. Effects of base slab offsets. Many 3-D monoliths have vertical offsets in the base slab, such as a miter gate sill. When this type of monolith is analyzed, the base slab must be accurately modeled so that the proper stiffness relationships are obtained in the analytical model. Several methods are described in ETL 1110-2-355.

i. Shear transfer between adjacent 2-D sections. Often portions of 3-D monoliths are analyzed using a 2-D method. For example, the lock walls of a miter gate monolith may be analyzed independently as 2-D models. A 2-D section can be cut from the 3-D model, and the appropriate loads and reactions from the 3-D model applied. However, this 2-D "slice" will usually not be in equilibrium because it is a part of a 3-D monolith; thus shear transfer will occur between adjacent 2-D slices. These shear forces must be calculated (summation of loads and reactions) and applied at appropriate locations over the 2-D cross section so that the model is in equilibrium. Shear transfer requirements are discussed in ETL 1110-2-355.

j. Articulated base slab. In certain circumstances, the use of an articulated base slab may be practical to

reduce concrete in the chamber monoliths. This reduction may be accomplished by placing a vertical joint in the base slab on each side near the face of the lock wall. This joint would be designed to transfer shear and axial forces but not moment. This process may reduce the concrete thickness and amount of reinforcing steel. This approach may be useful for monoliths that do not require unwatering such as approach monoliths.

9-3. Foundation Design and Soil/Structure Interaction

a. Site selection. The foundation conditions often influence the site selection for a lock project. Therefore, the foundation characteristics should be determined for each tentative site at an early stage of the investigation. These characteristics are usually determined by using available data and a minimum of foundation exploration. Sites chosen for further investigation should have foundation characteristics that would allow the lock structures to be constructed at a reasonable cost. The possible sites selected for study from a review of topography and hydraulics can thus be reduced to one or two after reviewing the site from a foundation and navigation standpoint. Final site selection requires extensive foundation exploration of the remaining sites under consideration.

b. Foundation type. Determining the type of foundation is probably the most critical aspect in the design of a lock. Since this decision will affect the project cost, the foundation type should be determined in the feasibility stage of the project. This analysis should involve the use of a thorough subsurface investigation and testing program to define the soil strengths and parameters. The criteria for selecting a soil or pile foundation are based on economic considerations and site-specific characteristics. Usually, a soil foundation is more economical if special measures (deeper excavation, elaborate pressure relief system, etc.) are not required. In addition, the structure on a soil foundation has to be able to satisfy stability requirements for sliding and overturning, as well as resisting flotation and earthquake forces. At some sites, liquefaction of the foundation during an earthquake becomes a determining factor in selecting the foundation type. Differential settlements between monoliths should also be considered in the foundation determination. If a soil foundation is not feasible or requires expensive special measures, then a pile foundation should be studied and compared to the cost of a soil foundation. The process for selecting a pile foundation should consider all reasonable types of pile and should select the most feasible solution based on the site geotechnical conditions, availability of material, and construction limitations. The

quantities can be based on minimum spacing and approximate lateral and vertical capacities for one or two typical monoliths. The most cost-effective type of pile is thus determined for comparison to the soil foundation. Computer programs such as CPGA (rigid base) or CWFRAM (flexible base) or other finite elements are useful for designing pile foundations. The final decision between a soil and pile foundation is then based on a cost comparison using these refined pile quantities. Detailed design guidance for pile foundations is contained in EM 1110-2-2906.

c. Foundation pressures (compatible deformations). Foundation pressures depend on the type of foundation material, the nature of the loading, and the size and shape of the monolith. For gravity-type monoliths (due to their rigidity), a linear distribution of base pressure beneath the wall can be assumed. However, for U-frame-type monoliths and other structural monoliths with a flexible base, the distribution of base pressure should be based on a soil/structure interaction analysis.

d. Bearing strength of soils. The bearing strength of soils and methods for its determination based on field and laboratory test data are described in EM 1110-1-1905. Another good reference for the calculation of bearing capacities is the program documentation for the CASE computer program CBEAR.

e. Base pressures and settlement. For a gravity-type lock, settlement analyses can be performed by following the principles set forth in EM 1110-1-1904. For a U-frame-type lock, the computer program CWFRAM can be used to obtain base pressures and associated base slab deformations. The most difficult aspect of this type of analysis is selecting representative soil moduli to input into the program CWFRAM that would relate moduli and deflection. Currently, guidance on selecting representative soil moduli for use in this type of analysis is limited, so the user should work closely with the geotechnical engineers. These analyses should be verified by a finite element program such as Soil-Structure Interaction Program (SOILSTRUCT). This program can account for the incremental construction sequence of the lock. As the instrumentation of the Port Allen Lock and the Old River Lock U-frame locks showed, the construction sequence can significantly influence settlements and lock wall movements.

9-4. Reinforcing Design

a. General. Steel reinforcement should be designed and detailed as specified in EM 1110-2-2104. Because of

the large wall and floor sections, reinforcement spacing should generally be set at 12 in. for ease of construction. However, in gravity walls, the requirements of EM 1110-2-2104 regarding the minimum steel do not apply.

b. Volume change induced cracking.

(1) Volume change in massive concrete occurs as cooling of the concrete takes place. The volume change can be minimized by reducing the heat generated by cement hydration. Reducing the heat is accomplished by replacing cement with pozzolan, cooling the aggregates in the mixture, and replacing some of the mixing water with ice. Also, limiting lift heights allows cooling to take place before the next lift is placed. Contraction joints are used to reduce tensile strains caused by cooling contraction and restraint at the foundation. Shrinkage (volume change caused by drying) is not considered a problem in mass concrete because drying only occurs at the outermost 6 to 12 in.

(2) In unreinforced mass concrete, once a crack is formed it can propagate throughout the structure. Heavy temperature reinforcement (number 9 bars at 12-in. spacings) can be used to prevent crack propagation and control crack widths (many small cracks rather than one large crack). Reinforcing for crack control may not be needed in massive sections (5 ft thick or more) because it is more economical to accomplish crack control using the measures described above. However, the presence of reinforcement provides a safety margin to prevent cracks at cold joints. In areas where volume change causes stress concentration, such as at the corners of the filling and emptying culverts, reinforcement should be provided to prevent cracks from propagating from the culvert to the outside face of the structure. In nonmassive concrete sections, temperature and shrinkage reinforcement is required to control cracking. Generally, small bars at close spacing provide the best control. However, for walls 2 ft thick or more, number 9 bars at 12-in. spacings are commonly used to ease construction while still providing the required steel percentage.

c. Recesses and openings. For reinforcing the corners of all lock wall recesses, diagonal bars should be used. In addition, reinforcing steel is sometimes used in the top of lock walls.

Chapter 10 Design of Lock Wall Accessories

10-1. General

This chapter provides details on the design of lock wall accessories. These items should be designed to comply with the safety requirements contained in EM 385-1-1.

10-2. Floating Mooring Bitts

a. General. The need for larger and stronger floating mooring bitts has been caused by the development of synthetic lines for checking and tying up the larger tows. The 2-in. synthetic lines now in use have a breaking strength up to 107,000 lb compared to the 31,000-lb breaking strength of new 2-in. manila lines which were the criteria used for the original development of the floating mooring bitts. All affected components of the floating mooring bitt should be designed for 160,000-lb load at normal working stresses. This force is derived from the parting strength of a doubled line reduced by a factor of 0.75 to account for unusual loading. Plate 39 provides further information on floating mooring bitts.

b. Recesses. At the lock face, a small recess opening should be provided to protect the bitt from damage by barges or from the twisting effect of line pull. A recess opening from 1.5 to 2.5 ft is recommended.

c. Embedded guides. The embedded guides should be composed of corrosion-resistant steel plate or corrosion-resistant clad steel plate. This material should be fabricated so that a large, rectangular cross-section track is provided instead of the rolled channel sections with tapered flanges that are in use in some projects. This flat shape gives the wheels wider faces on which to roll. This measure would also help alleviate flaking and pitting of steel faces that has been experienced with use of the rolled channel section guides. The guides should be adequately braced to resist displacement and distortion during placement of concrete and should be anchored into the concrete mass to transfer the large wheel loads to the concrete itself. The top of the guides should be terminated in a yoke arrangement to assure that the floating mooring bitt cannot accidentally be propelled out of its recess by buoyancy after the sudden release from the hold of ice or debris. This arrangement can also provide a means of hoisting and storing the bitt out of the water when it is not in use. Locks with the top of walls near upper operating pool should have the guides extended above the wall to accommodate the floating mooring bitt.

Guides extending above the top of the lock wall should also be encased in concrete.

d. Wheels and axles. The wheels should be as large in diameter as practical with a minimum of 12 in. to resist high stresses from overloading and impact. Wheels should be made of cast or forged steel with a corrosion-resistant steel rim either shrunk on or built up with weld overlay. Axles should be made of corrosion-resistant steel and should be as large in diameter as is practical to resist bending. Stops (or feet) should be provided at the bottom of the floating mooring bitt to prevent the bottom wheel from striking the floor of the recess and bending the axles. Stops should incorporate rubber bumpers to cushion the impact.

e. Wheel bushings and lubrication lines. Aluminum bronze is recommended for wheel bushings because it will perform better under heavy axle loads than most materials readily available. Graphite impregnated bushings are not recommended since it is not possible to obtain adequate bearing areas. Grease fittings should be provided for the lubrication of the wheel bushings and axles. Submerged wheels will require grease lines extending to the top of the tank. All grease lines should be located in the interior of the tank to prevent damage to the grease lines from debris and ice. To prevent leakage, welded-in couplings should be provided where lines pierce the tank.

f. Tank. The tank should be a minimum of one-fourth-inch-thick corrosion-resistant steel compatible with the corrosion-resistant steel guides. If the tank is being replaced on existing locks, the tank should be of the same material as the guides to prevent galvanic action between the two. If a carbon steel tank is used, either a fiberglass coating or cathodic protection or both should be provided. The shell should have circular transverse diaphragm rings on approximately 3-ft centers and reinforcing plates at stress points. A diameter of 3.5 ft should be considered for use on new designs. Where possible, tanks should be designed with a sufficiently high flotation level to allow a minimum adjustment of 18 in. in floating depth by an inert ballast material to compensate for future changes in weights and tow conditions.

g. Ladders. With the use of diaphragms, ladders are not essential inside the tanks and should not be provided.

h. Fiberglass coating. Instead of using paint, the outside of carbon steel tanks could be covered with fiberglass impregnated in a bituminous material. In prototype usage, this material has been proven to reduce maintenance costs and corrosion. If used, the fiberglass

coating should be periodically examined for cracks or leaks.

i. Cathodic protection. If carbon steel tanks are not coated with fiberglass, some type of cathodic protection should be provided. In past projects, sacrificial magnesium block or ribbon anodes, attached with welding studs at selected locations, have been used successfully.

j. Debris shield. If a wide recess opening is used, a shield should be mounted on the tank at the waterline to protect against floating debris.

k. Styrofoam-filled tank. Filling the tank with styrofoam, either partially or completely, is not recommended. This measure would prevent inspection of the inside of the tank, prevent the tank from being sunk should this be necessary, and may cause the tank to rust beneath the foam because of moisture entrapment.

l. Self-sinking device. To prevent the bitt from being suddenly propelled upward after sudden release from freezing or being jammed by debris, an automatic sinking device should be provided to permit the tank to fill with water. The water can be forced out later by using compressed air. The compressed air inlet connection must be extended above lower pool when the floating mooring bitt is resting on the bottom of its recess.

m. Mooring posts. Posts for floating mooring bitts should be fabricated from 8-in.-OD, 1-in.-thick wall steel tubing, ASTM A618, Grade 1, with properties suitable for welding and with a yield point of 50 ksi.

n. Single-deck floating mooring bitts. The loaded - unloaded draft differential of modern barges can be as much as 7 to 8 ft. In the case of empty jumbo barges, the kevel may be as much as 10 ft above water; as a result, mooring with a single-deck floating mooring bitt could be difficult and dangerous. Consequently, single-deck bitts are not recommended.

10-3. Line Hooks and Check Posts

Although not directly related to floating mooring bitts, a vertical row of heavy line hooks for checking tows (to discourage checking on floating mooring bitts) should be provided at each bitt and at 150-ft intervals in the wall faces outside the lock chamber. Check posts should be provided at the top of the wall at each of these locations. The hooks and posts should be fabricated from 8-5/8-in.-OD, 1-in.thick wall steel tubing ASTM A519, Grade 4130, condition SR, and filled with grout. Cast-iron or

cast-steel should not be used because it is harder to get quality castings. The hook, post, and anchorage should be designed for reactions resulting from a 160-kip line pull. The arrangement should include curved steel frame and adequate anchorage reinforcement. Plate 40 includes more information on line hooks and check posts.

10-4. Tow Haulage Unit and Movable Kevel

The recommended line capacity of a tow haulage unit with a pair of hoists should be about 5,000 to 7,000 lb with a maximum speed of 50 to 60 ft/min. Electric drive must have a variable speed control, as the barges will accelerate very slowly. However, hydraulic controls are not suitable for these hoists. For a single-hoist layout, a maximum line pull of 10,000 lb is recommended, so as not to break the normal hawsers used on barges. A speed of 80 to 100 ft/min may be used. Speed and line pull control on recent units is through an eddy-current coupling controlled by a stepless auto transformer unit. For layout description of tow haulage units and movable kevels, see paragraph 5-11.

10-5. Wall Armor and Corner Protection

The rubbing and scraping action of barge tows in contact with the lock walls will wear down and frequently damage unprotected concrete surfaces. To prevent this concrete damage, a facility should be equipped with horizontal runs of T-section wall armor as well as horizontal and vertical corner protection. Horizontal wall armor and horizontal corner protection should not cross monolith joints. Preformed plates or castings are used at the top of lock walls and at exposed corners of recesses for miter gates, lift gates, bulkheads, ladders, line hooks, and mooring bitts. Currently, the standard wall armor section is rolled infrequently (only for a certain tonnage by a single manufacturer). If the minimum order of T-sections cannot be met even by combining demands, a T-section may be fabricated from plates. If any doubt exists as to availability of the T-section during preparation of the contract drawings, the fabricated section should be detailed on the drawings as an alternate. Horizontal timber, steel box, or rubber sections have also proven suitable for protection from tow abrasion. Plate 43 also illustrates typical details.

10-6. Guardrails

a. Stationary. A stationary rail or permanent fixed guardrail should be provided for the top of lock walls and for service gate and bridge walkways. These rails are required for safety around any openings in the top of the

lock wall that are not equipped with covers. If the public is allowed on the lock walls, then appropriate wire mesh panels or other details must be provided for additional safety. Rails next to lock faces should be set back a sufficient distance so that overhanging barge rakes do not destroy them. Some locks have been designed using concrete parapets instead of railing at the lock face. Local conditions, including climate, will usually govern whether concrete parapets or rails are used. The location of the rail or parapet should account for the space required for a present or future tow haulage unit. Ample room (rail clearance) should be provided to allow easy access to check posts. Under no condition should the rail be positioned over the check posts where it would interfere with lines using the posts.

b. Laydown. Laydown (collapsible) railing should be used on the top of lock walls where the lock walls are subject to being overtopped by floodwaters. Plate 54 provides design details.

10-7. Parapet Walls

On some locks, concrete parapet walls have been used at the lock face instead of guardrailing. The walls are usually tapered away from the lock face to minimize damage by barge contact. The parapets must be reinforced to resist a barge contact load. Some factors involved in deciding whether to use railing or concrete parapets include climate, especially snowfall; lock wall overtopping; and presence of, or anticipated presence of, a tow haulage unit railroad rail.

10-8. Grating

Recesses in the top of lock walls should be provided with covers, usually of grating fabricated with steel or other appropriate material, to permit safe movement of lock personnel, equipment, and visitors. In some instances, the grating may be covered with steel plate for safety purposes. When a mobile crane is provided, the grating must be designed for the resulting wheel loads. However, large openings, such as miter gate machinery recesses or valve pits, may be left open and protected by guardrails on top of a raised concrete curb.

10-9. Trash Racks

Structural steel trash racks are required at the culvert intake manifold ports at the lock face. These trash racks are necessary to keep large debris out of the intakes and culverts. This prevents large items from blocking water flow, obstructing proper culvert valve operation, or

damaging the valves. The trash racks should be firmly anchored in place so that the frequent flow of water through the racks does not cause them to be dislodged and lost. However, the detail of the anchorage should be such that the trash rack can be easily removed and replaced (especially in locations where zebra mussels are a problem).

10-10. Second Placement Concrete

Certain locations in a lock require precise alignment and elevation settings for the following embedded items: the steel sealing surfaces for the culvert valves and culvert bulkheads; the vertical wall quoin and the horizontal sealing surfaces for the miter gates; the bearing and sealing surfaces for the closure structures; operating machinery foundations; and other items. These second pour items require careful sizing and detailing so that enough space is available for adjusting the steel items to line and grade. This space will also allow for placing and vibrating concrete.

10-11. Gauges

Gauges are installed in recesses in the face of the lock walls at suitable locations to indicate the depth of water over both the upper and lower sills. The gauges usually are placed so that the top of the adjacent sill is the zero of the gauge; thus the depth of water over the sill is read directly off the gauge in feet and tenths. Numbers on the gauges should extend a few feet below low water and above high water. Gauges are located a short distance upstream and downstream from each service gate recess and on the wall opposite the normal operating wall, so the numbers are visible to lock operating personnel. Recording devices are also provided on locks to register on the control panels. These devices should be located inside the operations building and inside the control stations to display both the upper and lower pool elevations and lock chamber water elevations at all times for the convenience of the lock operating personnel. Selysen transmitters located at appropriate places have been used for this gauging purpose on more recent lock designs. Pressure sensors that furnish data for visual display or a Cathode Ray Tube (CRT) screen in the control stations and operations building are now in use for the above purposes on many locks.

10-12. Distance Markers

Numbered signs indicating the distance to the lock sill should be painted at the top of the lock approach walls and lock chamber walls. These signs should comply with

the sign manual EP 310-1-6A and 6B. Figures should be 12 in. high for good visibility from the pilot house of the incoming vessel and are normally spaced at 100-ft intervals. Markers on the lower approach wall show the distance to the downstream end of the lower gate recess; those on the upper approach wall show the distance to the upstream end of the upper gate recess. Markers in the lock chamber show the distance to the downstream face of the upper miter sill, which is also identified by a vertical yellow stripe on the face of both lock walls. The distance markers may be painted directly on the concrete, or they may be painted on aluminum or plastic plates which are mounted in shallow recesses in the face of the lock wall or supported on the guardrailing. Figures are generally white on a green background, and facilities may use a reflective type paint for easier reading at night.

10-13. Instrumentation (Structural)

A variety of instrumentation may be required for gathering structural related data. These data may include the

following: uplift pressures, concrete monolith tilt, steel sheet pile cell interlock tension or cell movement, tie-back tendon or rod tension stress, crack width, pore pressure, interior concrete temperature, leakage, and pressures in culverts. EM 1110-2-4300 provides guidance for most of the required structural instrumentation.

10-14. Air Bubbler System

Service gate sills for miter gates and sector gates should be provided with air pipes located a few feet above the bottom of the gate recess and the gate sill and discharging near the gate pintle and miter point. A bubbler system is useful in moving floating items out of the quoin and miter areas during gate operation. This system helps to prevent gate damage caused by floating items caught between gate and wall contact blocks and miter contact blocks. Bubblers are automatically operated. For other type lock gates, air bubbler systems should also be provided.

Chapter 11 Design for Operation, Safety, and Maintenance

11-1. General

The objective for design of modern navigation projects is to provide navigation locks that are operationally and functionally reliable. Important design objectives are to minimize staffing requirements, improve operational efficiency, and decrease lock downtime for maintenance and replacement of operating components. Other design objectives include providing low life-cycle maintenance costs, mobile access to all parts of the structure for operation and maintenance, access for the disabled, and safe operating conditions for personnel and navigation. This final objective can be achieved by installing automated operating systems; centralized control of lock and dam operations; automated visual, audio, and electronic surveillance systems; command and control communication systems; real-time condition sensors for lock gates; valves and operating equipment; automated data collection systems; and spare parts, spare gates, and spare operating equipment for fast replacement of damaged components. An operation and maintenance plan addressing these features is developed by the engineering division and submitted for review during the feasibility report stage of design.

11-2. Design for Operation

a. Operating control systems. The design of control systems for navigation locks can involve three levels of technology. Locks with low volumes of commercial traffic and higher volumes of recreational use may justify the installation of more manual systems. Locks with high volume of commercial traffic on main stem river navigation systems should incorporate automated technology. An intermediate system based on current technology could be a centralized semiautomated system backed up by a local control system as described in Appendix C.

(1) Local hardwired control systems. Hardwired control systems with control panels located at each gate have traditionally been used for operation of navigation locks and dams. This system is based on 1930's technology and has proved to be reliable and reasonably safe based on over 50 years of operational experience. However, some accidents have occurred because of the inability to detect if miter gates closed properly without the automated interlock controls. This system is

manpower intensive requiring an operator to be present at each gate station.

(2) Computer-based control systems. With current technology, operating systems for navigation locks can be designed using computer hardware, software, electronic visual systems, and fiber optic networks to operate a complete lock and dam from a central control station with one operator. The present design of operating systems for navigation structures is moving in this direction. However, since this ultimate system has not been fully installed, the performance and safety of this system has not been measured. The design for navigation structure control systems should ease into this new technology with a blend of computerized systems backed up by the traditional system that allows control from local stations for emergencies and maintenance.

(3) Semiautomatic control system. A computer-based, semiautomatic control system has the capability to allow an operator to control one or two locks and a gated dam from one location. The following system is used at Melvin Price Locks and Dam on the Mississippi River and reflects the state of technology at the time of installation in 1992. This installation is more completely described in Appendix C. Control systems based on this concept use computers networked to programmable logic controllers (PLC's). Monitoring the lock project for both operational and security purposes is accomplished through closed circuit television (CCTV). A video and computer network link can be established with district or regional control centers for rapid communication of important developments. A semiautomatic control system can control a complete lockage through the initiation of several control sequences. The operator initiates the sequence through computer monitors and receives computer-generated feedback that prompts the operator through the complete sequence of a lockage. A manual mode provides individual operation of any piece of machinery from the central control console via a computer keyboard. Local control can be provided from control stations on the lock walls. In the manual and local control modes, all interlocking functions can be maintained, since control logic is still performed in the PLC. In the event of PLC failure, hardwired emergency controls can be provided for continued operation. A computerized, hierarchical graphics display system can provide supervision of equipment status and can alert the operator to equipment malfunctions (see Figure 11-1). The operator can select, in increasing levels of detail, computer-generated graphic displays of systems or subsystems. The last level of detail in the graphics system is operation and maintenance



Figure 11-1. Graphics display system

information which can be output to a printer for rapid response to equipment failure. Daily, weekly, or scheduled maintenance and testing functions can be displayed and checked off when completed in the computer data base.

(4) Central control system. At Melvin Price Locks and Dam, the control of the entire facility will be accomplished by a network of distributed intelligence. A complete, independent PLC system will be used to control each lock (the main lock PLC will also provide remote control of the dam). The PLC's will gather and monitor data, perform logic and interlocking, and actuate equipment and devices. Each PLC will be directed by a series of personal computers (PC's). The PC's will communicate directly with the PLC's. The PC's will function as an operator interface, operate as a host to several algorithms for control, and will provide executive control of the PLC's. A PLC lockout system is provided at the

central control console to prevent inadvertent operation of the system when the console is unattended. In the event of PLC malfunction, hardwired backup controls located at the local control stations can be used for continued operation. This system architecture will provide redundancy, reliability, and minimal impacts because of equipment failure. All lock gates, navigation approaches, lock chamber operations, and project areas will be monitored electronically at the central control house through CCTV, sound systems, and surveillance systems.

(5) Data acquisition. Using this system, data acquisition can be computerized for real-time inputs for lockage data, weather and river information, lock conditions, tow information, and all other system information. These data can be accessed at remote locations such as district offices, regional control centers, and other locks in the system.

(6) Command and control. River discharges, pool elevations, and gated spillways can be controlled from the computerized system, either at the project site or at a remote location such as a regional control center for several locks in a navigation system.

(7) Advantages and disadvantages. The semiautomatic system as described is based on present technology and has been implemented at the Melvin R. Price Locks and Dam on the Mississippi River. This system is economically advantageous with estimated operational savings of approximately \$4.5 to \$8 million over the life of the project. This system can be incorporated into the automated operation of several locks in the Upper Mississippi River project as additional locks in the system are modernized.

(a) Advantages. Computerized control systems offer certain inherent advantages over electromechanical relay systems. They are extremely flexible and can accommodate radical changes to control philosophies through simple programming changes. They offer the ability to develop complex control algorithms capable of executing complex instructions such as those required to automate pool levels. The computer systems used for the automated controls can also function as a convenient storage device for large databases, such as navigation data, operation procedures, equipment descriptions, maintenance instructions, and performance information.

(b) Disadvantages. The disadvantage to the operation of computer systems is the learning curve necessary for the lock personnel to operate and maintain the system, along with the associated computer literacy skills. Other disadvantages of computer systems involve human factors such as the difficulty in adjusting to remote interfaces that do not allow direct visualization of lockages. These systems are also more complex and require higher skill levels to maintain, although operationally they may provide more comprehensive operational command and control.

b. Surveillance, communication, and security systems.

(1) Centralized control with closed circuit television (CCTV) and radar. The automated systems described above are designed to operate the locks with a minimum of lock operating personnel (one in the control house, the other roving the structure). Therefore, while the centralized control station should be located to take advantage of direct visibility, it should be with supplemented electronic visual information. The CCTV should be strategically located to allow views of the entrance and egress of all navigation as well as the critical areas within the lock and

dam. The CCTV should monitor all lock and spillway gate operations. Provisions should be made for the operator to exit to the local control stations should the CCTV equipment malfunction. Radar systems should also be considered to monitor navigation or barges during fog or low-visibility conditions.

(2) Signal and communications systems. Signal and communication systems need to be provided and should consist of the following components:

(a) Navigation traffic light signals to control movement of the vessels in and out of the lock.

(b) Strobe lights for recreational vessels to request a lockage.

(c) Public address system for communication around the complex and between the lock operator and persons on vessels in the lock.

(d) Horn signals for alerting persons on tows or recreational vessels. Sirens, if necessary, to signal opening of culvert valves. An emergency howler to alert lock personnel for emergencies.

(e) Portable communication walkie-talkies for communication with personnel around the navigation complex.

(f) FM and marine band radio equipment for communication with land stations and marine navigation.

(3) Security and surveillance systems. A plan should be developed for security of the installation, especially if a minimum of lock operating personnel are present. Security systems can consist of security fencing with remote electronic monitoring, alarm systems, motion detectors in sensitive areas, CCTV surveillance systems, sound monitoring of visitor areas, elevators and access points, and gated entry points operated from the control house. All security systems need to be controlled and displayed from the central control house. Emergency alert stations should be provided at strategic places on the lock structures.

c. Ice control measures. Although ice presents a difficult design problem, several design and operation features can improve the efficiency of lockages during icy conditions. While improving efficiency of lockages during ice conditions, these measures carry a penalty of higher cost and increased mechanical and operational complexity.

(1) Lock gates. At locations with dual locks or locks in a canal, submersible lift gates have been provided at one or both locks to pass ice over the top of the gates. The lift gates are mechanically more complex and not as economical as miter gates; however, they perform better in ice conditions. The floating ice in the approaches or ice being pushed by the tow can be flushed over the top of the lift gate and out of the lock chamber with the lower gates open. For a lock with miter gates, the ice has to be locked through with the operation of the miter gates being impeded by the floating ice. To operate miter gates with heavy floating ice generally requires the use of the prop wash from a switch boat to move the ice out of the miter gate recesses through the lock chamber. Projects that have dual locks of the same size present an ideal situation for handling ice. The land lock would have upstream miter gates while the river lock has a lift gate upstream. During normal operation, the land lock would be used for downbound traffic as the pilots prefer to remain close to the bank for downbound approaches. During icy conditions, the river lock would be used for downbound because the tow would push the ice in front over the lift gate to be flushed downstream. The land lock would be used for upbound as the tows would be exiting the lock pushing the ice on upstream away from the lock. The downstream approaches are generally free of ice below the spillway. The river lock with the lift gates requires a higher sill to recess the lift gate. The land lock can have a lower sill to allow the passage of emergency floating plant in case of loss of pool.

(2) Spillway gates in separation between locks. If the dual locks are separated, then spillway gates can be provided in the separation to keep floating ice flushed from the upstream approaches. The separated locks with controlled flow between the locks have the further advantage of aligning the flows parallel with the lock, thus reducing outdraft into the main dam. In addition, if the locks are separated sufficiently, then the tow can take advantage of simultaneous approaches and departures.

(3) Bubbler systems. High-volume air bubbler systems placed in gate and floating mooring bitt recesses can remove floating ice from these areas and also prevent ice from forming on the surfaces. Large-volume compressed air barriers have been installed in the approaches to Melvin R. Price Locks to shunt the ice from the approach into spillway gates in the gated dam in the separation between the locks. This type of system functions by raising the water with a compressed air curtain that creates a current away from the approaches to remove the floating ice from the approaches.

(4) Ice booms. Ice booms have been used to keep ice out of the approaches; however, these booms have to be moved, or an opening should be provided to allow passage of tows.

(5) Trickler systems. Trickler bubbler systems installed along the lock walls, recess, and gates at the lock floor elevation can raise water from the bottom of the lock that is one or two degrees warmer to prevent ice from forming on the surfaces.

(6) Copolymer coatings. The Cold Regions Research Laboratory (CRRL) has proposed the use of copolymer coatings on lock walls and lock miter gates to prevent ice buildup. The coating prevents ice adhesion to the wall. Because the Corps has not tested this application, CRRL should be contacted for information on this application.

(7) Miter gate recesses. Deeper recesses in the lock walls can be provided to allow room for the gates to open with ice or debris trapped in the recess. However, to fit the culverts, machinery, and galleries, this feature requires wider lock walls at the gate bay location.

(8) Heating elements. Heating elements can be used for gate and floating mooring bitt recesses. These elements can be embedded in the wall or on the steel gates and bulkheads. Steam systems have been successfully used to remove ice loadings from gates and walls.

11-3. Design for Safety

Safeguards should ensure that people who use, operate, or visit the navigation facility can do so without risk of personal injury. All possible measures should also be taken to minimize accidents and effects of accidents due to tow entrance or egress. All designs should be in compliance with EM 385-1-1 and OSHA safety standards.

a. Emergency barriers. Emergency barriers are devices that prevent barges from impacting the lock operating gates. These barriers can be composed of large steel cables or chains with counterweights on either end. When a ship or tow strikes a barrier, the kinetic energy of the barge is changed to potential energy by lifting the counterweight or compressing the shock absorber. Emergency barriers have been provided at locations where damage to or loss of gates would result in catastrophic consequences. Although used for deep draft locks (St. Lawrence Seaway and the Sault Ste. Marie Locks), a feasible emergency barrier has not been devised for inland

waterway locks for raked shallow draft barges. In January 1978, a study was conducted for the Bay Springs Lock and Dam by the Nashville District of a rope cable barrier system. This study concluded the following:

(1) A tow could strike the barrier from underneath when the lock chamber is being filled. If the tow strikes the barrier at that time, the tow could sustain damage, destroy the barrier, and endanger the life of anyone on the tow. The same dangers could be present for a tow in the lock chamber when the lock is being emptied if the tow should hang in the ropes of the barrier.

(2) The cost of the barrier system could be better invested in improving the miter gates for preventing tow collision and providing spare units to replace any damaged portion of the gates.

b. Accidents involving barges. The design should incorporate an emergency plan of action for accidents from out of control barges impacting the structure. This plan should address emergency removal of sunken barges from the lock and dam structures. Equipment such as overhead cranes and floating plant with emergency procedures must be available to quickly remove these obstacles and restore the function of the structure. Heavy floating plant and cranes intended to service several lock projects may be located at a central location. Thus, in case of loss of pool, sufficient depth (8 ft or more) should be provided over the upper and lower sills to allow passage of the floating plant from a remote site. In addition, if a barge-mounted derrick crane is intended to service several projects, access to both the upstream or downstream end of the lock must be provided when the lock is obstructed and passage through the lock is impossible. Recommendations developed after the incident in 1967 at the Markland Lock and Dam on the Ohio River provide useful guidance to be considered during design (see Appendix D for detailed recommendations).

c. Accidents involving hazardous cargo. Plans should be developed to prevent, contain, and clean up spills from hazardous or HTRW. These plans should address emergency operations and evacuation of personnel and public. Provisions should be made to contain hazardous material in the event of a spill. A lock and dam project should be constructed to contain spills which occur either in the pool formed by the project or in the lock approach or lock chamber. Operating procedures should be developed for containing and collecting the spill material. Plans should be developed in coordination with other agencies.

d. Fire protection systems. A high volume, raw water pumping and piping system should be provided to all parts of the lock and dam structures. This system should provide water to extinguish small fires and provide water for spray systems to cool the lock gates in case of fire in the lock chamber. For projects that handle a large volume of traffic containing petroleum or other flammable material, special equipment should be considered to extinguish or control a fire in the lock chamber. Fire fighting and evacuation plans should be developed and coordinated with local officials for major emergencies caused by fire, explosions, or hazardous spills. Evacuation plans for surrounding public should be developed with the local agencies. See EM 1110-2-2608 for additional information.

e. Instrumentation. Instrumentation is provided to monitor the safety performance of lock structures. Special instrumentation may be provided to verify design assumptions and to provide data for research and development needs. Instrumentation requirements are covered in EM 1110-2-4300. The design for lock instrumentation, including automation of data collection with and schedule of readings, will be presented in a design memorandum. Instrumentation should be designed to monitor the lateral, vertical, and rotational movement of the lock monoliths. The movements should be correlated with the change in loading conditions (change in pool, tailwater, and uplift conditions). The degree of sophistication that can be employed in the design will depend on the project site conditions. The types of instrumentation based on an automated data acquisition system (ADAS) that can be provided are as follows:

(1) Piezometers. Piezometers are necessary to monitor the uplift pressures beneath the lock structures during the service life. Piezometers can be the open-system type with stainless steel wire-wound well screens that are fitted with a vibrating wire pressure transducer to permit water level monitoring with the ADAS. Other piezometers can be designed to be monitored manually with a portable water level indicator.

(2) Inclinerometers. Inclinerometers installed in casings in selected lock monoliths monitor the lateral movement of the monolith through the service life. The inclinometers should be terminated in rock or deep enough to record zero movement. The inclinometers can be monitored using a cable-supported probe which is lowered in the casing and retrieved at 2-ft increments as the slope angle of the casing is measured.

(3) Trilateration target points. Trilateration target points can be mounted on the top of each lock monolith to monitor horizontal movements of the top of the lock using electronic distance measuring survey equipment. Coordinates of the points on the lock can be measured relative to fixed benchmarks located off the structure. Satellite global positioning systems (GPS) are being investigated for use as trilateration points.

(4) Tiltmeters. Biaxial tiltmeters can be mounted in galleries in the lock monoliths to monitor rotation of the lock monoliths during the service life. Tiltmeters can consist of permanently mounted biaxial servoaccelerometer devices which can be monitored with the ADAS or manually.

(5) Monolith joint indicators. Several types of monolith joint indicators can be used to monitor relative movements of adjacent lock monoliths. These types are manual and automatic devices. Manual devices can consist of the steel ball, shim, and feeler gage devices, and the surface reference bolt system monitored with a reference beam dial gage indicator. Automated devices connected to the ADAS can consist of linear motion potentiometers and direct current differential transformers. The transformers are the preferred automated devices.

(6) Inverted pendulum. Lock displacements can be monitored manually by trilateration and inclinometers. To make an automatic measurement of lock displacements, an inverted pendulum with an automatic monitoring system connected to the ADAS can be installed.

(7) Sounding wells. Sounding wells can be provided through the pile founded lock structures to monitor vertical displacement of the foundation materials below the structure.

(8) Seismic instrumentation. Seismic instrumentation in seismically active areas can also be a project requirement. This instrumentation can be connected to the ADAS.

(9) Automated data acquisition system (ADAS). An ADAS should be considered to automate the reading, recording, and evaluation of instrumentation data. The ADAS can be used to monitor the vibrating wire piezometers, biaxial tiltmeters, inverted pendulum, monolith joint movement indicators, and seismic instrumentation. These transducers can interface with the ADAS using a controller mounted on the lock structure. The controller can connect to water level transducers to read simultaneous pool and tailwater levels. In addition, water and air

temperatures can also be recorded. The ADAS can be located at a remote site such as the district office or in the project central control house.

11-4. Design for Maintenance

a. Selection of materials. In general, materials should be selected for a minimum life cycle cost. Critical components (something that could cause lock shutdown for long periods to unwater and repair) should first be designed for long-term reliability. Critical components should also be designed for easy replacement.

(1) Concrete. Where concrete surfaces are subject to underwater abrasion, design alternatives should consider the use of polymer reinforced and resistant aggregate concretes. Concrete surfaces should be designed to minimize damage from ice and snow. A plan for snow and ice removal should be developed that does not include the use of corrosive deicers. The design should consider heating elements and openings on top of the lock walls to push snow through. Openings in handrails and parapets should also be provided for snow removal. All concrete surfaces should have adequate sloping surfaces for drainage. All structures that can pond water should have appropriate drain holes provided to remove moisture. Joints should be designed to prevent freeze-thaw spalling of concrete or attack from abrasion of rubbing barges.

(2) Metals. All designs for structural steel gates, bulkhead, valves, and other steel items should be reviewed to ensure that adequate drain and air escape holes have been provided. Any place where water may collect and pond should be drained. Gates that are submerged should have adequate air release holes to prevent any tendency for floatation during submergence. The use of corrosion-resistant (not plated) steel is encouraged for hydraulic piping, submerged items such as floating mooring bits, and high-maintenance steel items that are difficult to access without shutting down and unwatering the lock. Special attention should be given to joining dissimilar metals to prevent the potential for cathodic corrosion.

(3) Corrosion protection. A number of different methods to prevent corrosion range from paints to cathodic protection. All of these alternatives should be studied to determine the most appropriate method of protection. This study should address life cycle evaluation of paints, galvanizing, metalizing, corrosion-resistant materials, and cathodic protection.

b. Spare gates and operating equipment. A study should be performed to determine the need for spare gates

and operating equipment. If these features are justified, then a plan should be developed for providing spare lock gates, lock valves, spare machinery components, and spare floating mooring bits to replace components in case of accidental damage. For critical locks, the design should include spares and equipment to complete replacement without the necessity to unwater. The lock must have access to the necessary floating and land-based equipment to facilitate the replacement of the components. In addition, the high-cost components should be designed so that the broken part of those components can be replaced at low costs or sacrificial items can be designed into the linkages. Components for several locks on a navigation system should be standardized so that parts are interchangeable. The plan developed for spare gates and operating equipment should be presented in the feasibility report or a design memorandum.

c. Lock unwatering. A plan for unwatering the lock chamber, gate bay, or culvert valve should be developed and presented in a design memorandum. In general, locks need to be capable of being unwatered for inspection and maintenance to an elevation which will not be exceeded by a 10 percent frequency for tailwater stages with free-board sufficient both for swellhead and wave heights. Site-specific conditions may require deviation from these criteria. Built-in submerged pumps for unwatering should not be installed as they present long-term reliability problems. Pumps can be designed into the structure to facilitate the unwatering operation. A semicircular or box-type cofferdam that can be placed against the lock wall and unwatered to inspect and repair localized areas should be considered as equipment for unwatering.

Chapter 12 List of Plates

Cofferdam

1. Three-Stage Cofferdam Scheme
2. Emergency Floodway and Spillway
3. Downstream Cellular Tie-in to Concrete at Lock Monolith
4. Upstream Cellular Tie-in to Concrete at Lock Monolith
5. Temporary River Closure

3-D Lock Presentation

6. Elements of a Lock - Gravity (Type)
7. Elements of a Lock - Combination Type
8. Isometric of Red River Lock No. 4

Lock and Dam Plan

9. Two Separated Locks - 1,200-ft Chambers (Simultaneous Approach)
10. Twin 1,200-ft Locks (Smithland)
11. A 1,200-ft Main Lock and 600-ft Auxiliary Lock with Common Wall (L27)
12. Single Locks (Schematic Separated and Adjacent) on Red River
13. Sector Gate Lock - General Plan and Typical Cross Sections
14. Sector Gate Lock - Sections and Details

Lock Chamber Sections

15. Gravity and Semigravity Walls - Monolith Layout
16. Gravity and Semigravity Walls - Land Wall Sections
17. Concrete U-frame Lock (Dry Dock) - Plan and Sections
18. Tied-Back Bay Springs Lock Wall
19. Sheet Pile Lock
20. Temporary Lock (Lock 53 - Ohio River) - Plan and Sections

Approach Walls

21. Single Lock Plans
22. Double (Twin) Lock Plans

23. Lock Guide Wall - Precast Concrete Beams on Concrete Filled Cells
24. Guide Walls Cast-in-Place on Tremie Filled Sheet Pile Cells
25. U.S. Guide Wall Cast-in-Place on Caissons - Isometric Views
26. Lock Guide Wall Cast-in-Place Concrete (Dry Condition SX)
27. Guard Walls - Concrete Bull Nose Monolith and Curved Wall Monolith
28. Guard Boom - Floating Concrete Box - General Arrangement
29. Guard Boom - Floating Concrete Box and Fenders

Filling and Emptying Systems

30. Chamber - Side Port Type
31. Chamber - Bottom Lateral Type (Barkley Lock)
32. Chamber - Bottom Longitudinal Type
33. Multiport System (Cordell Hull Lock)

Low-Lift Navigation Lock

34. Concrete "U" Frame - Typical Culvert Valve Monolith

Lock Gates and Sills

35. Low-Lift Navigation Lock - Upper Sill with Vertical Lift Gate
36. High Upper Sill - High Lift Lock - Sill with Tainter Gate (Upper Gate Delle Lock)
37. High Upper Sill - High Lift Lock - Sill with Lift Gate (Upper Gate John Day Lock)

Miscellaneous Accessories

38. Lock Accessories - Monolith Layout and Elevation of Lock Wall
39. Floating Mooring Bits
40. Line Hooks and Check Posts
41. Low-Lift Navigation Lock - Concrete "U" Frame - Sheet Pile Cut-Off Walls
42. Typical Lock Monolith Joint - Joint Details and Waterstop Details
43. Wall Armor and Corners

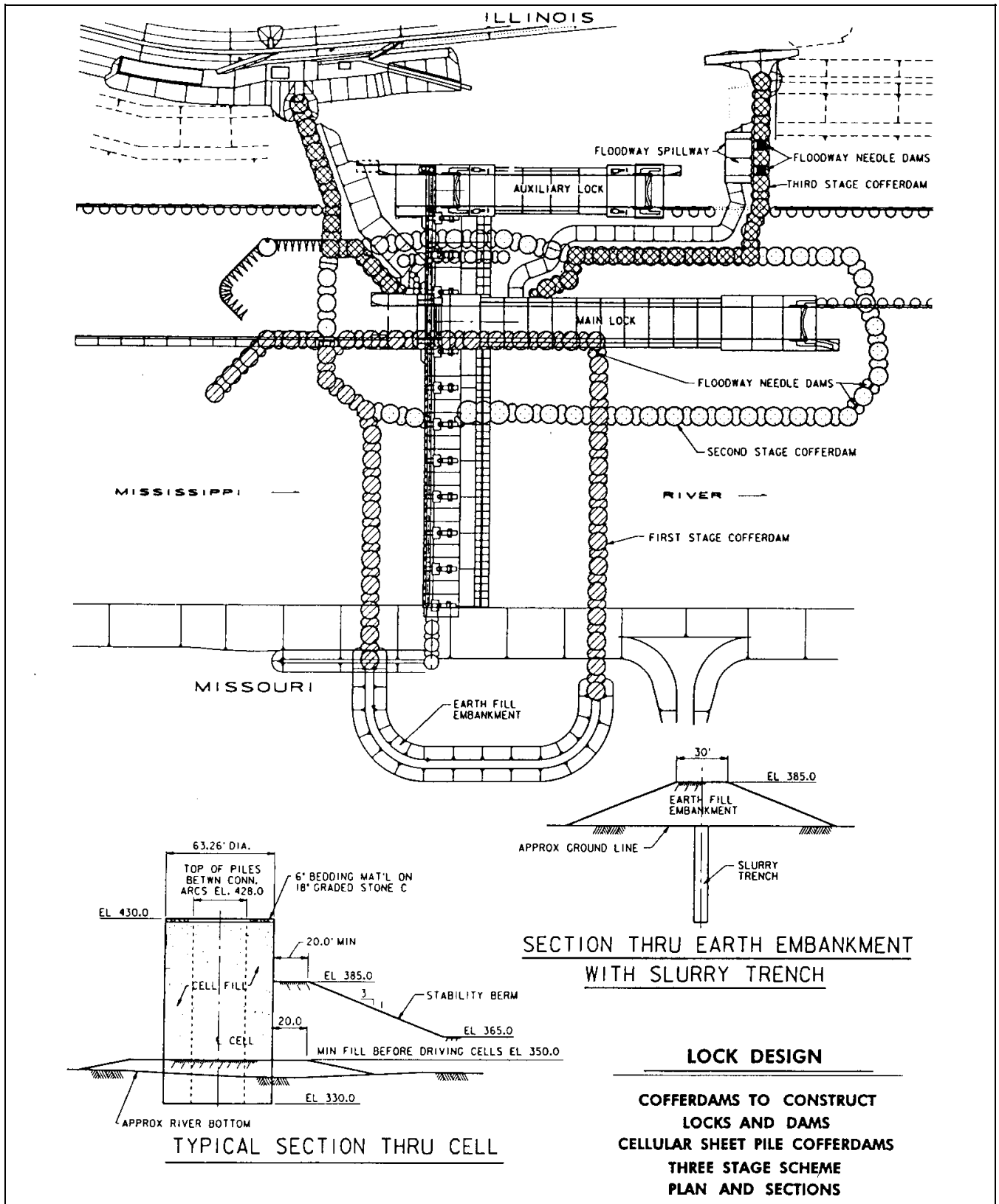

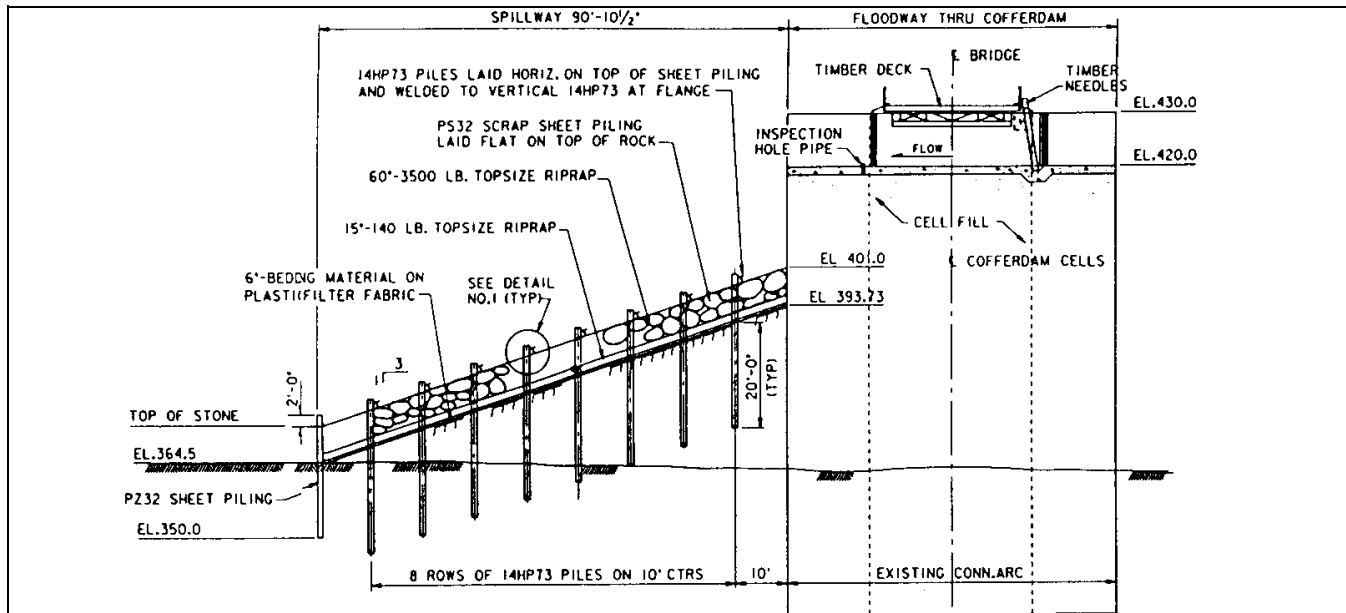

SECTION THRU FLOODWAY & SPILLWAY

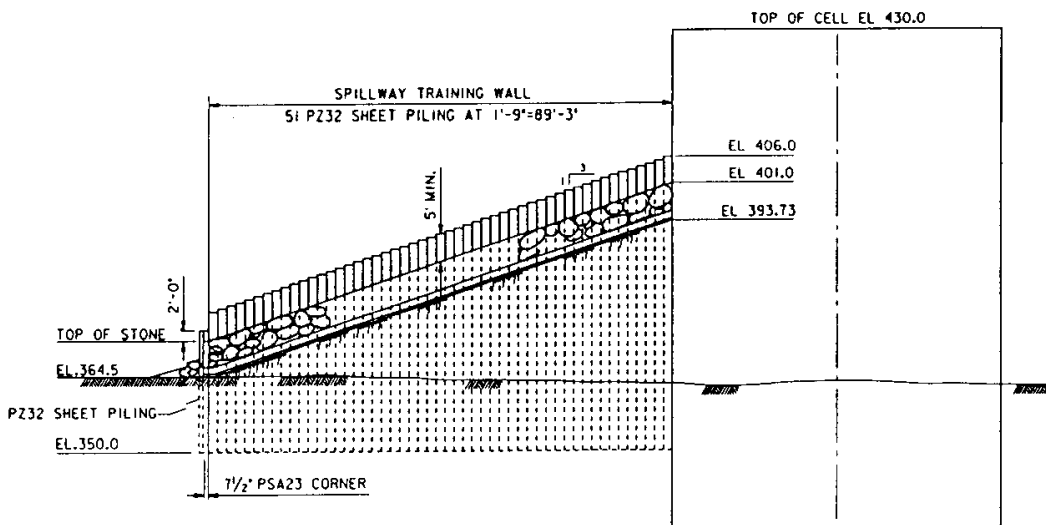

SECTION AT SHEET PILE TRAINING WALL

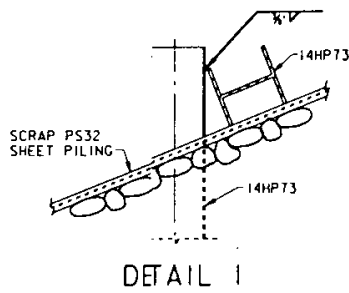

DETAIL 1

LOCK DESIGN

**COFFERDAMS
EMERGENCY FLOODWAY
AND SPILLWAY
SECTIONS AND DETAIL**

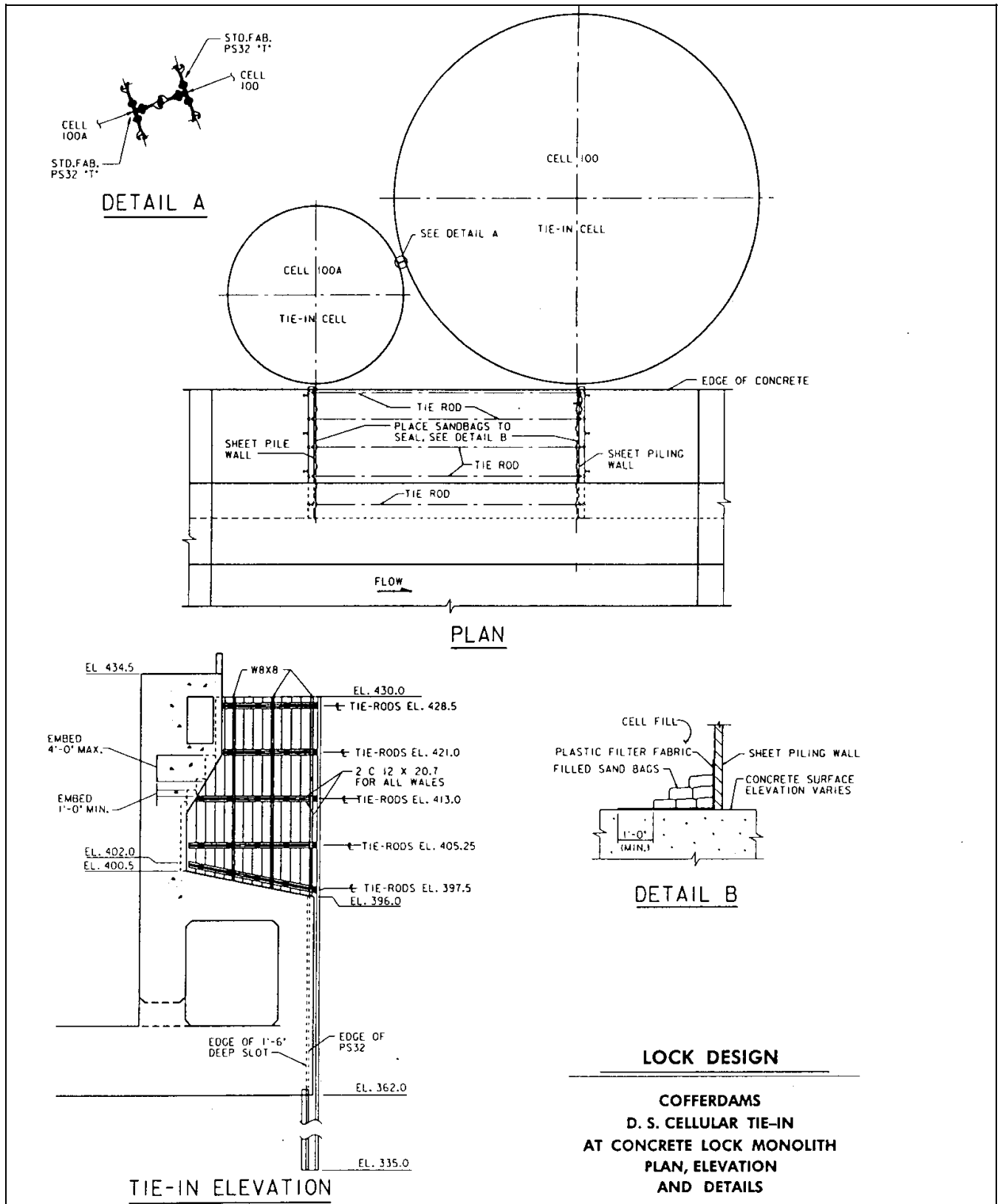

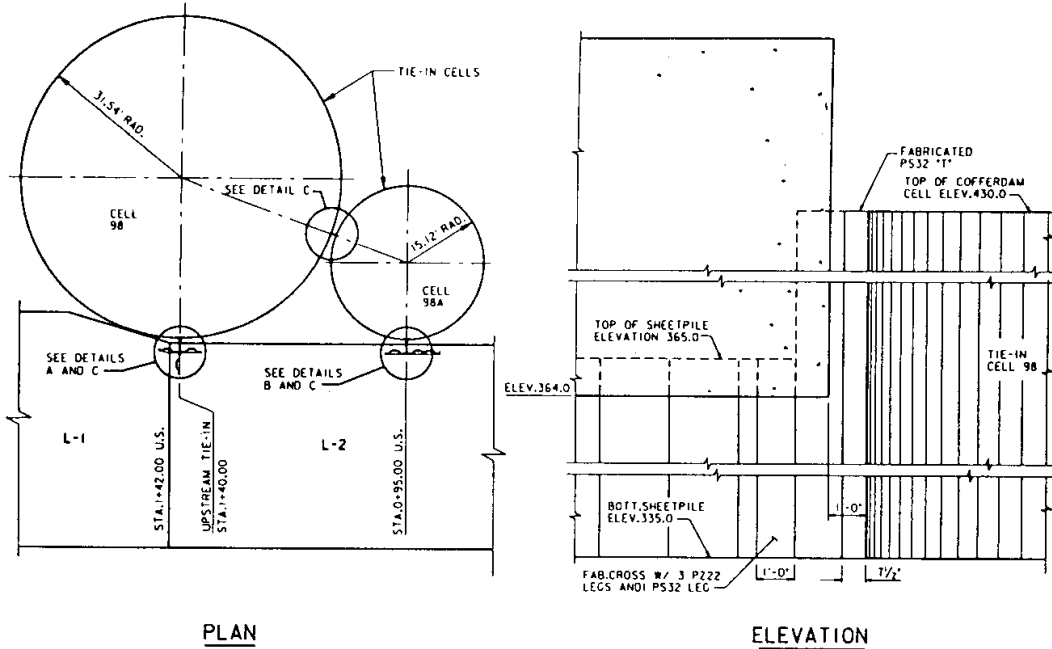

PLAN

ELEVATION

U.S. COFFERDAM TIE-IN AT LOCKWALL

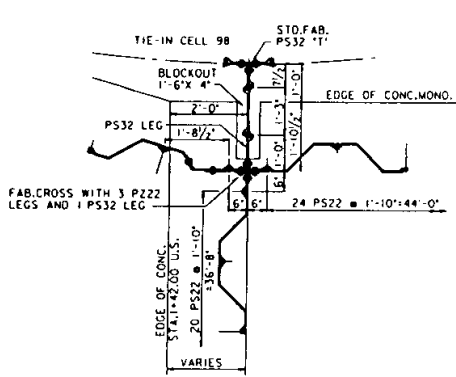

TIE-IN AT
FOUNDATION SHEET PILING
DETAIL A

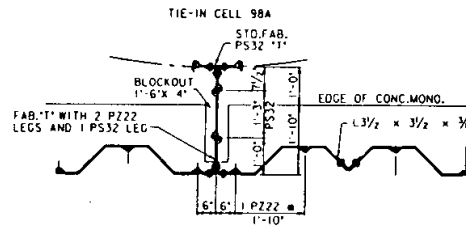

TIE-IN AT
FOUNDATION SHEET PILING
DETAIL B

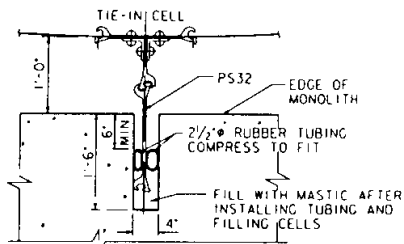

DETAIL C

LOCK DESIGN

COFFERDAMS
U. S. CELLULAR TIE-IN
AT CONCRETE LOCK MONOLITH
PLAN, ELEVATION
AND DETAILS

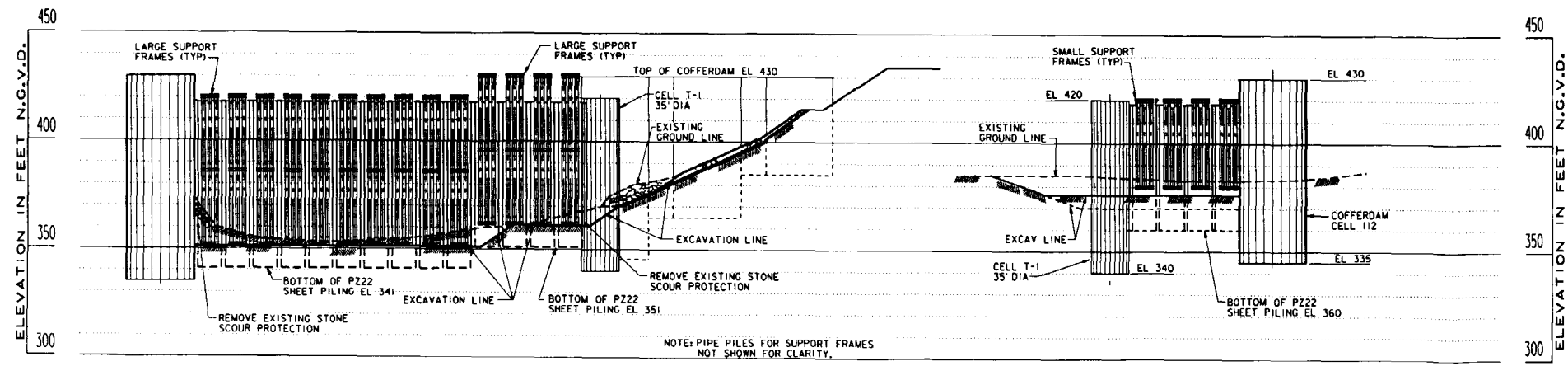
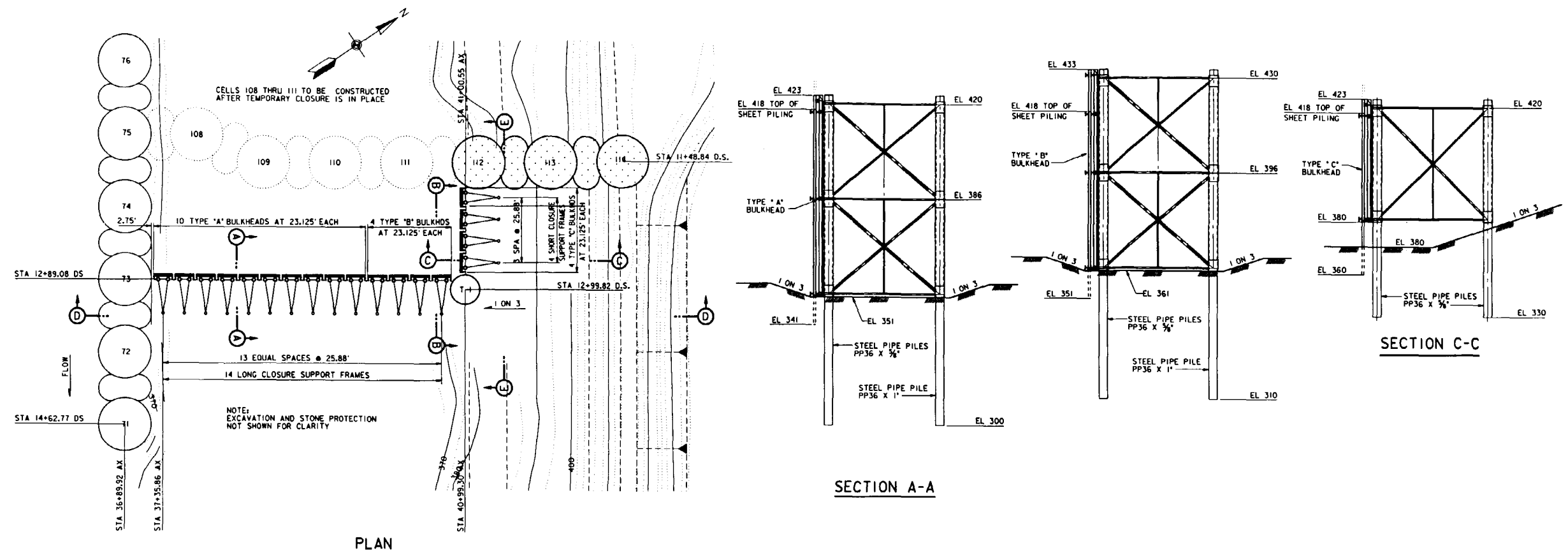

DOWNSTREAM SECTIONAL ELEVATIONS

VERTICAL SCALE: 1" = 25'
HORIZONTAL SCALE: 1" = 50'

LOCK DESIGN

COFFERDAMS
TEMPORARY RIVER CLOSURE
GENERAL ARRANGEMENT
PLAN AND SECTIONS

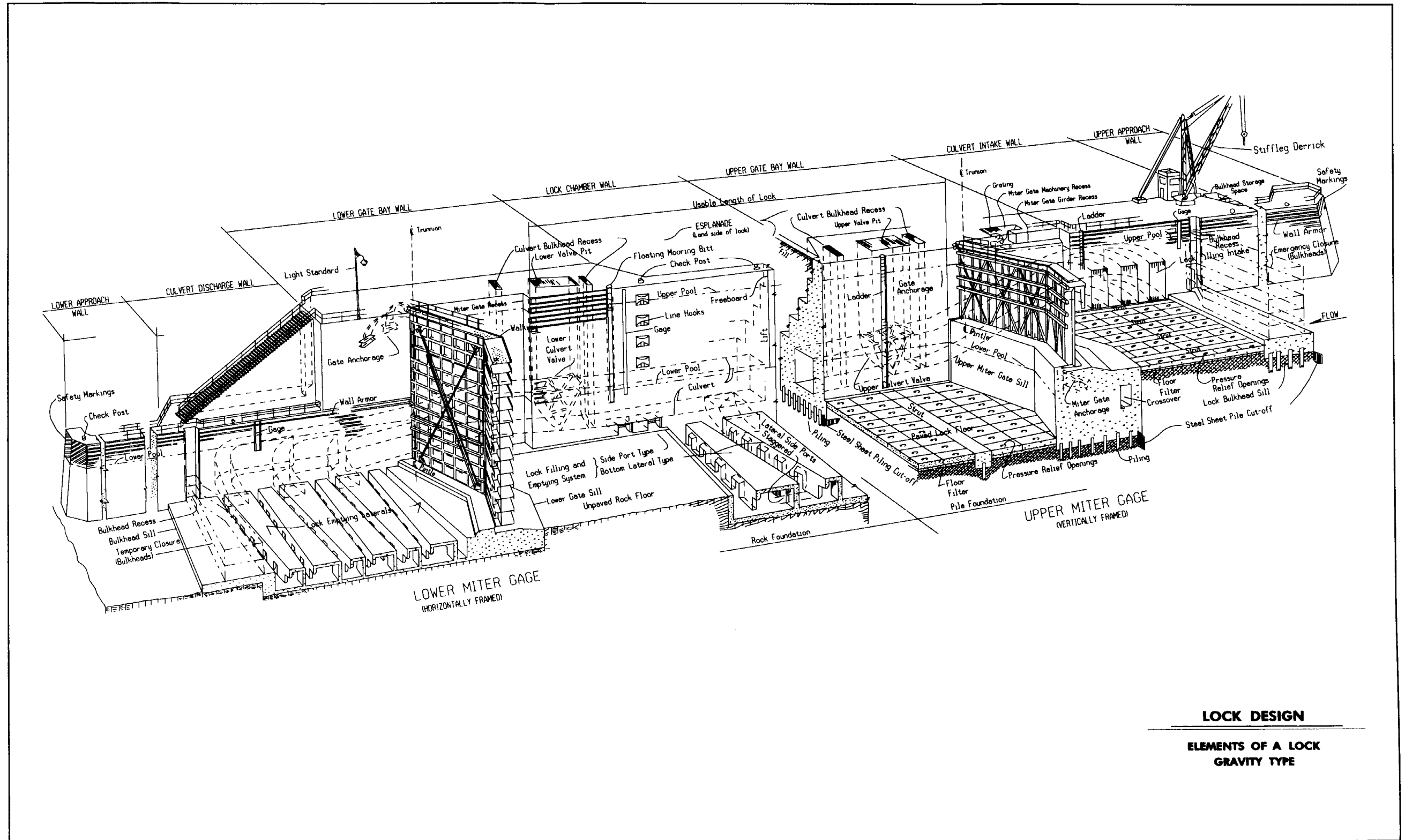

LOCK DESIGN

**ELEMENTS OF A LOCK
GRAVITY TYPE**

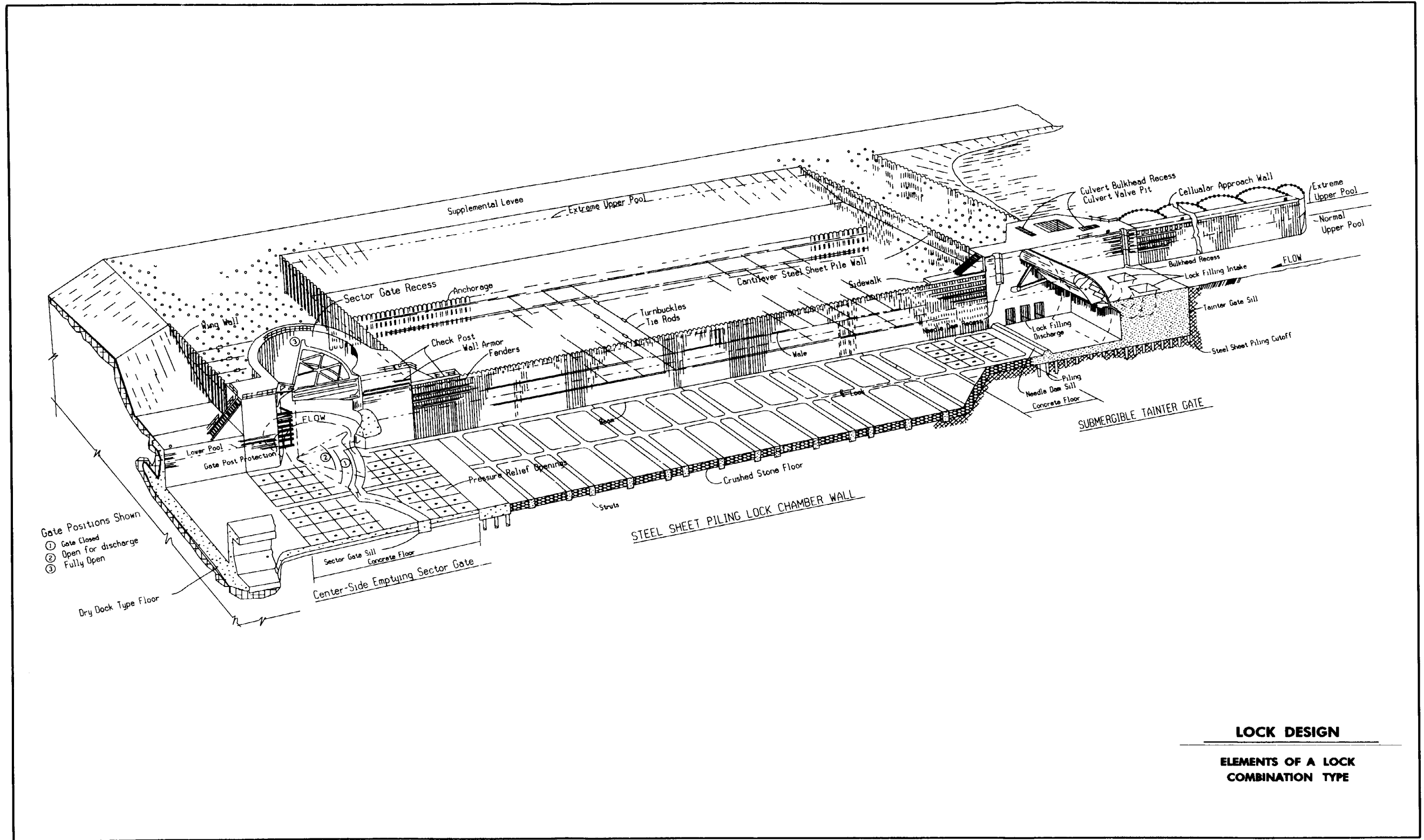

LOCK DESIGN

**ELEMENTS OF A LOCK
COMBINATION TYPE**

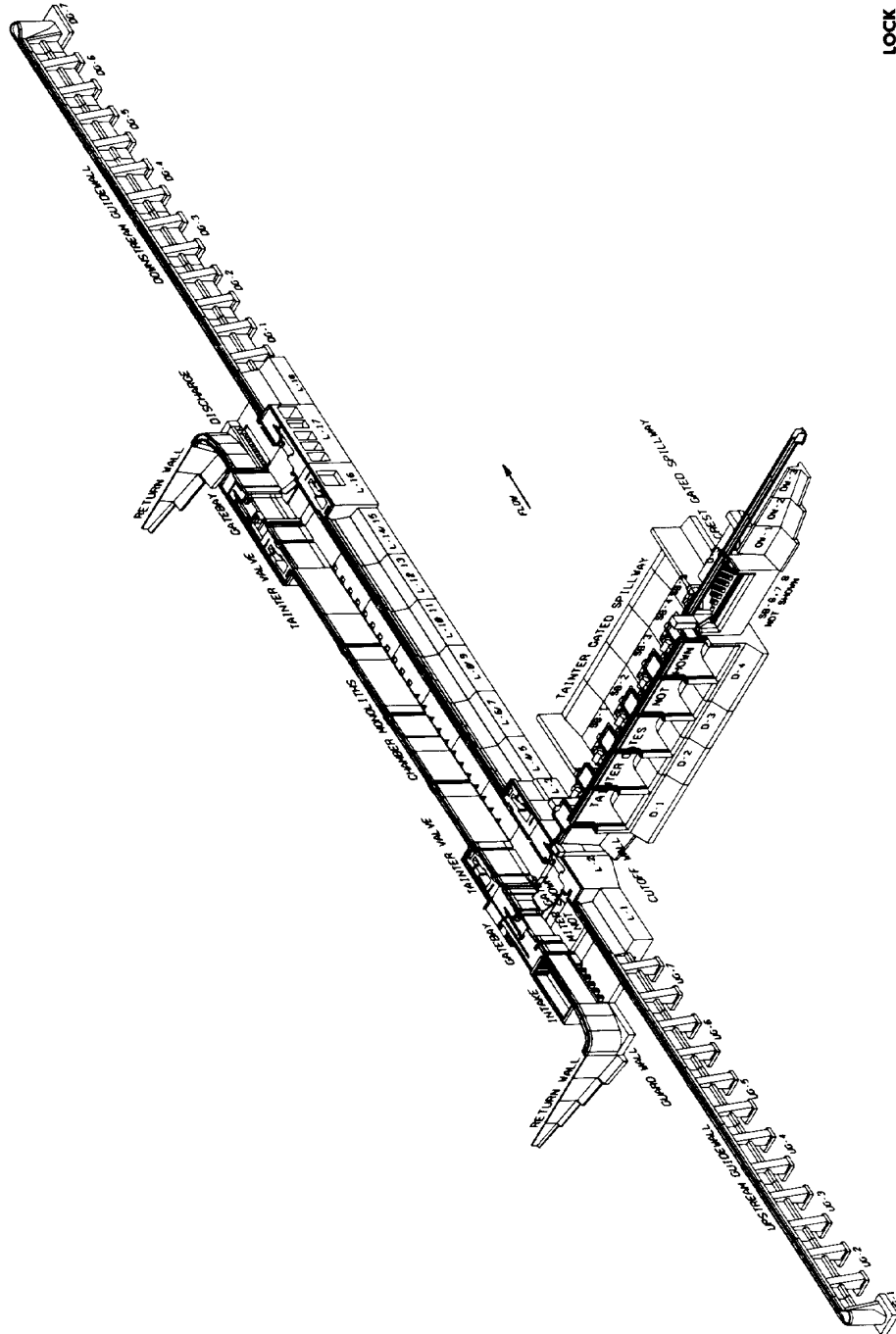

LOCK DESIGN
RED RIVER WATER WAY
LOCK AND DAM NO. 4
ISOMETRIC VIEW

LOCK & DAM NO. 4
COUSHATTA, LOUISIANA

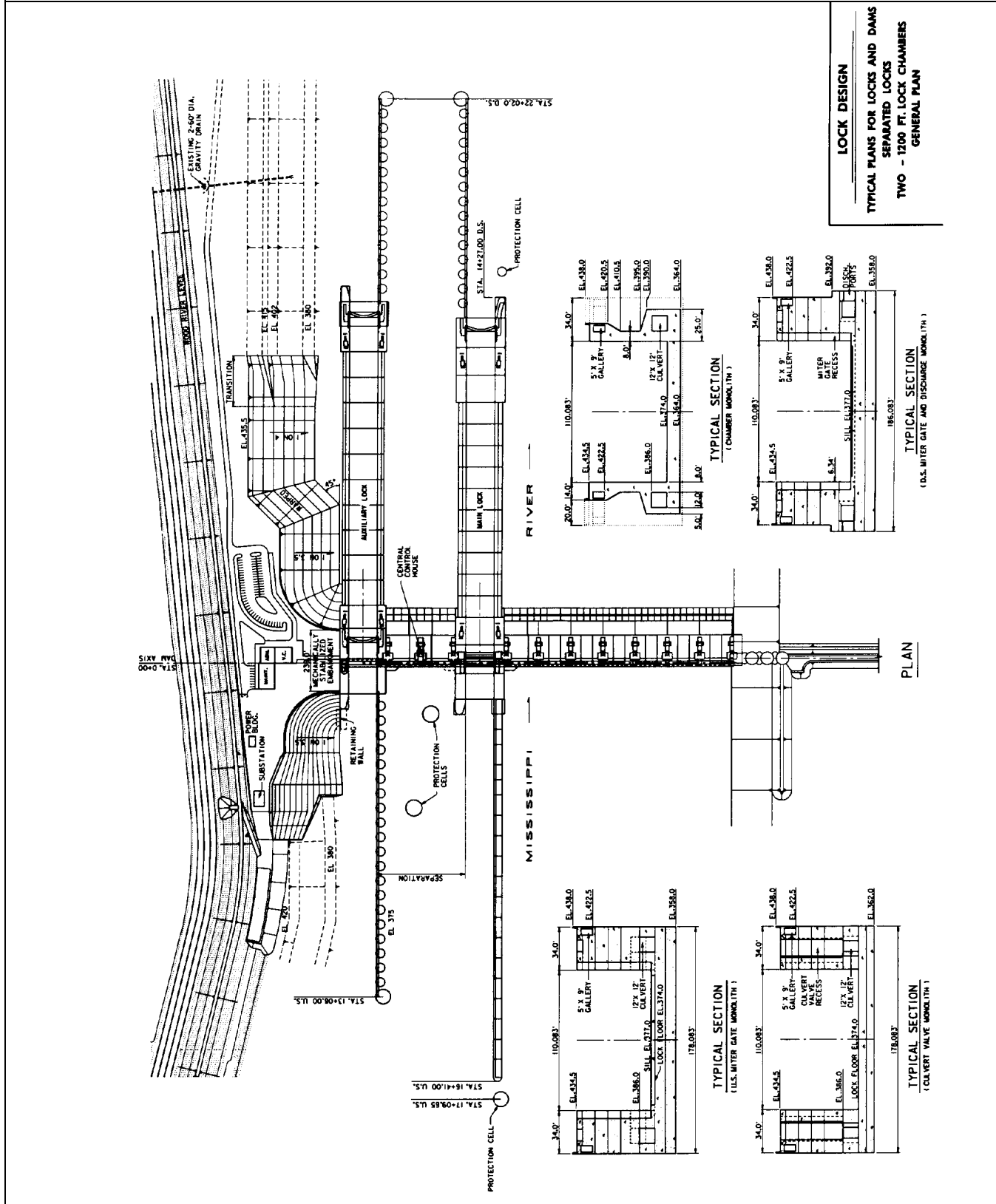
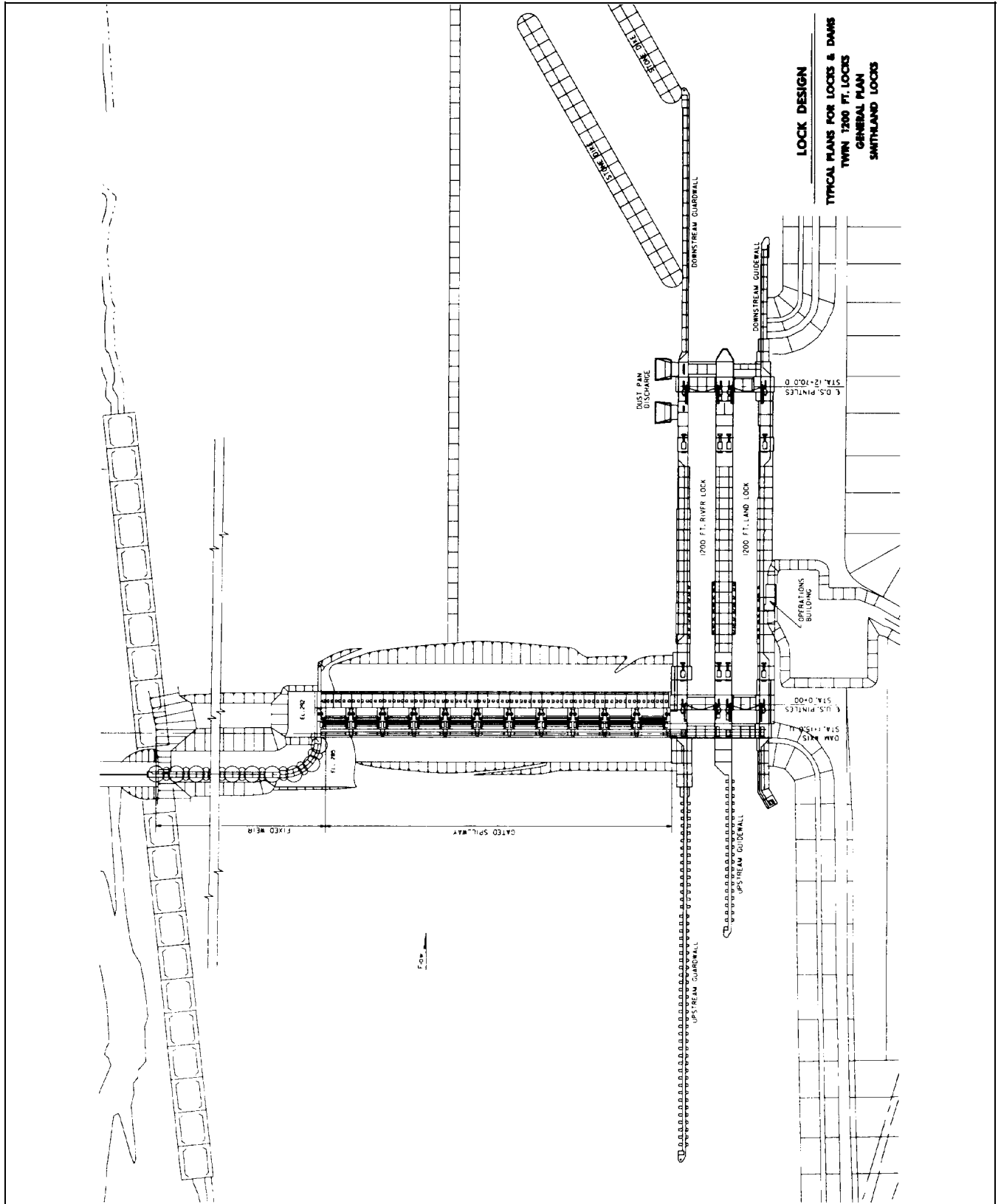
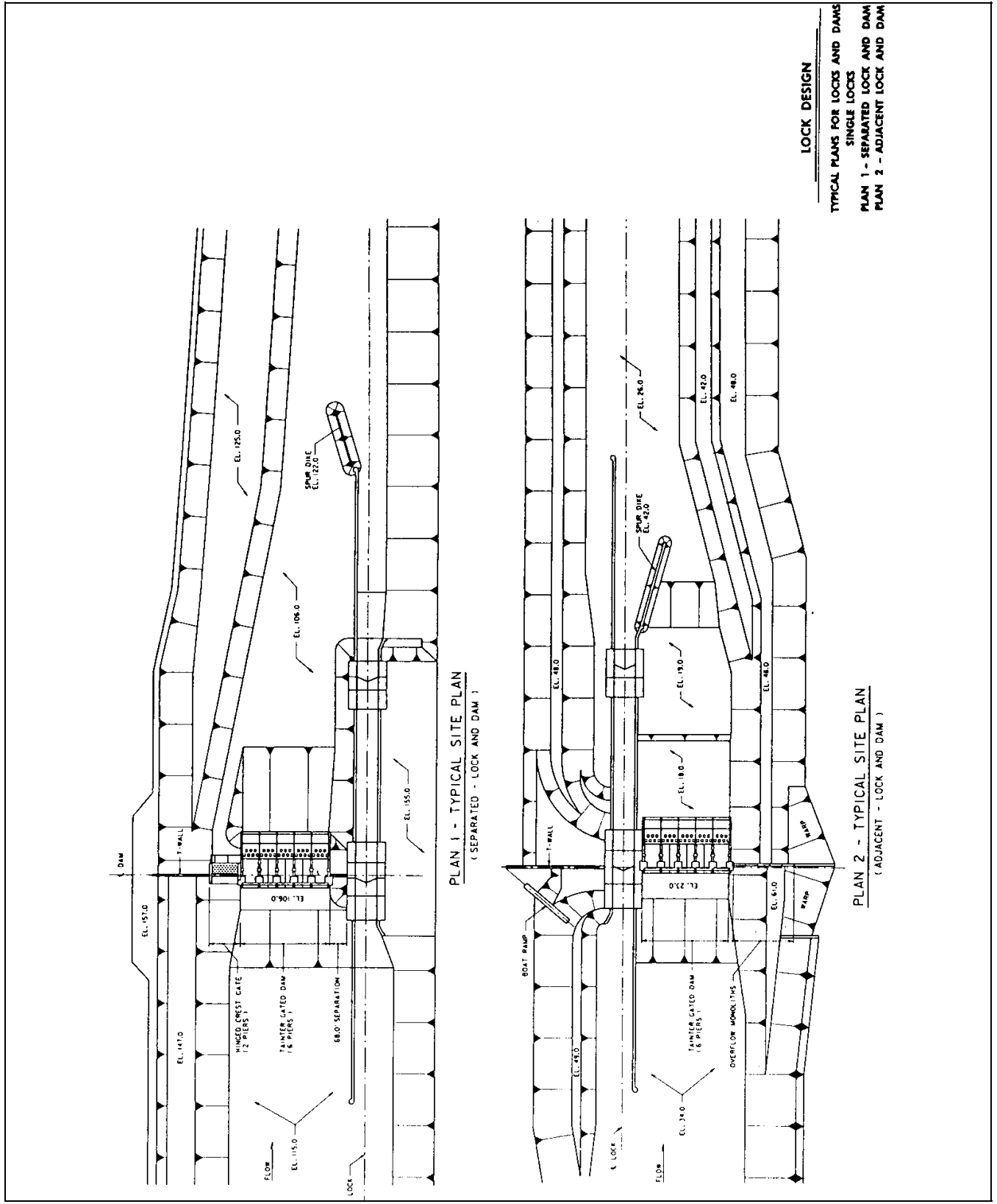

Plate 9





LOCK DESIGN

TYPICAL PLANS FOR LOCKS AND DAMS
 SINGLE LOCKS
 PLAN 1 - SEPARATED LOCK AND DAM
 PLAN 2 - ADJACENT LOCK AND DAM

PLAN 1 - TYPICAL SITE PLAN
 (SEPARATED - LOCK AND DAM 1)

PLAN 2 - TYPICAL SITE PLAN
 (ADJACENT - LOCK AND DAM 1)

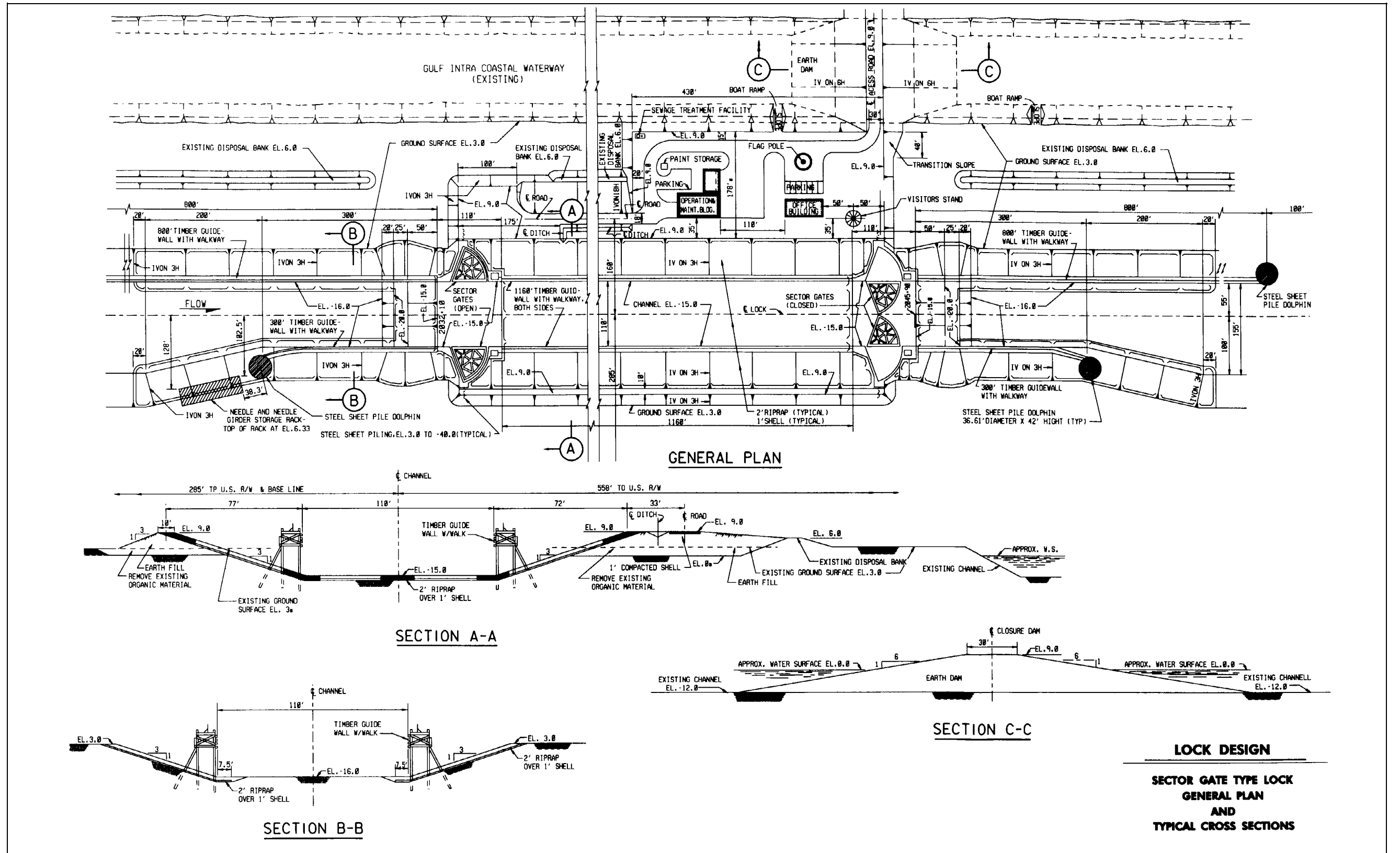

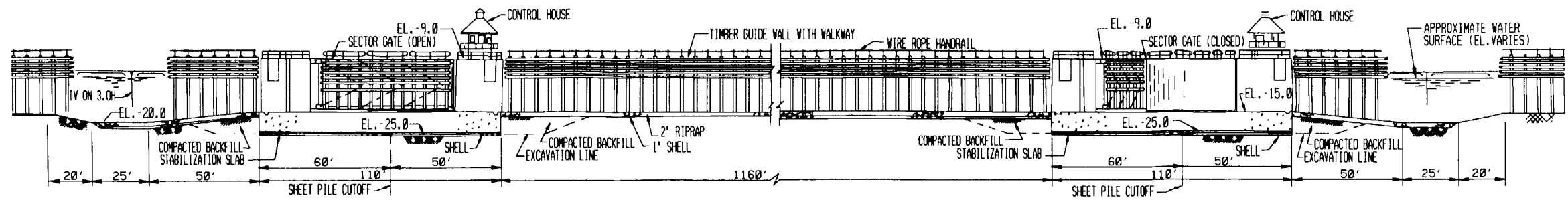

LONGITUDINAL ELEVATION

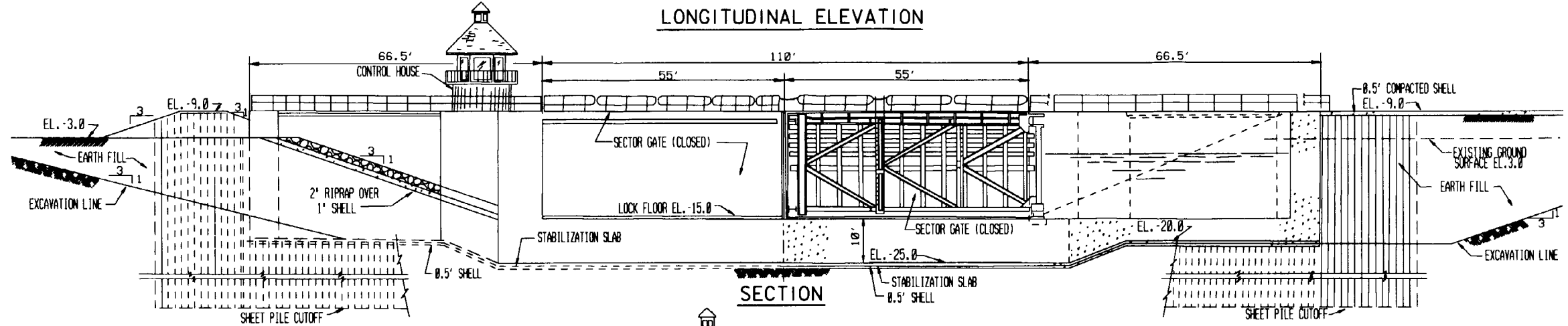

SECTION

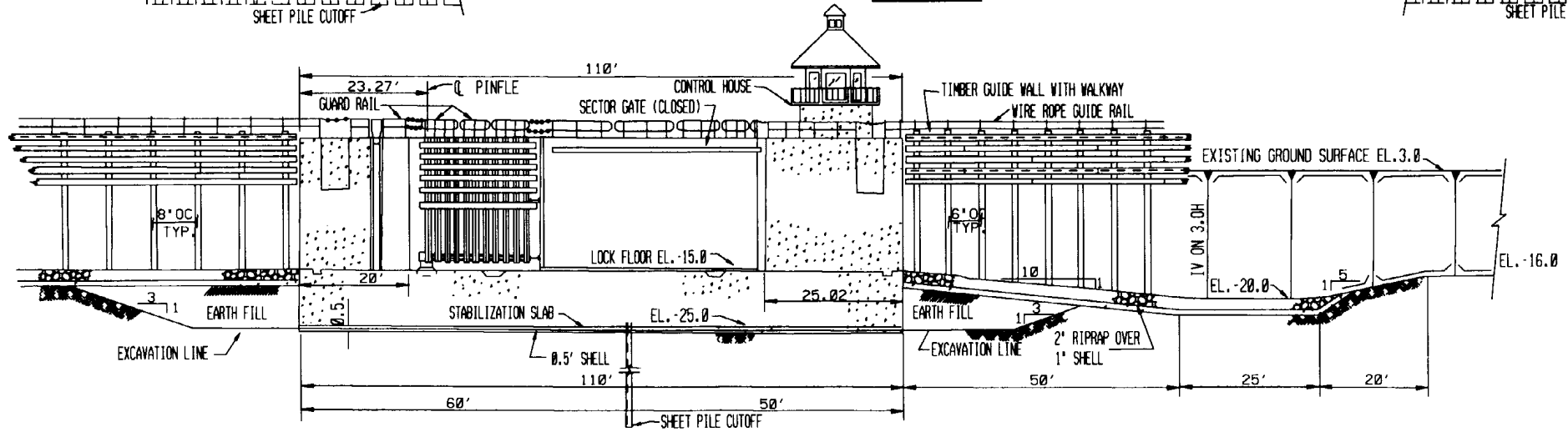

LONGITUDINAL ELEVATION- EAST GATE BAY

LOCK DESIGN
SECTOR GATE TYPE LOCK
SECTIONS AND DETAILS

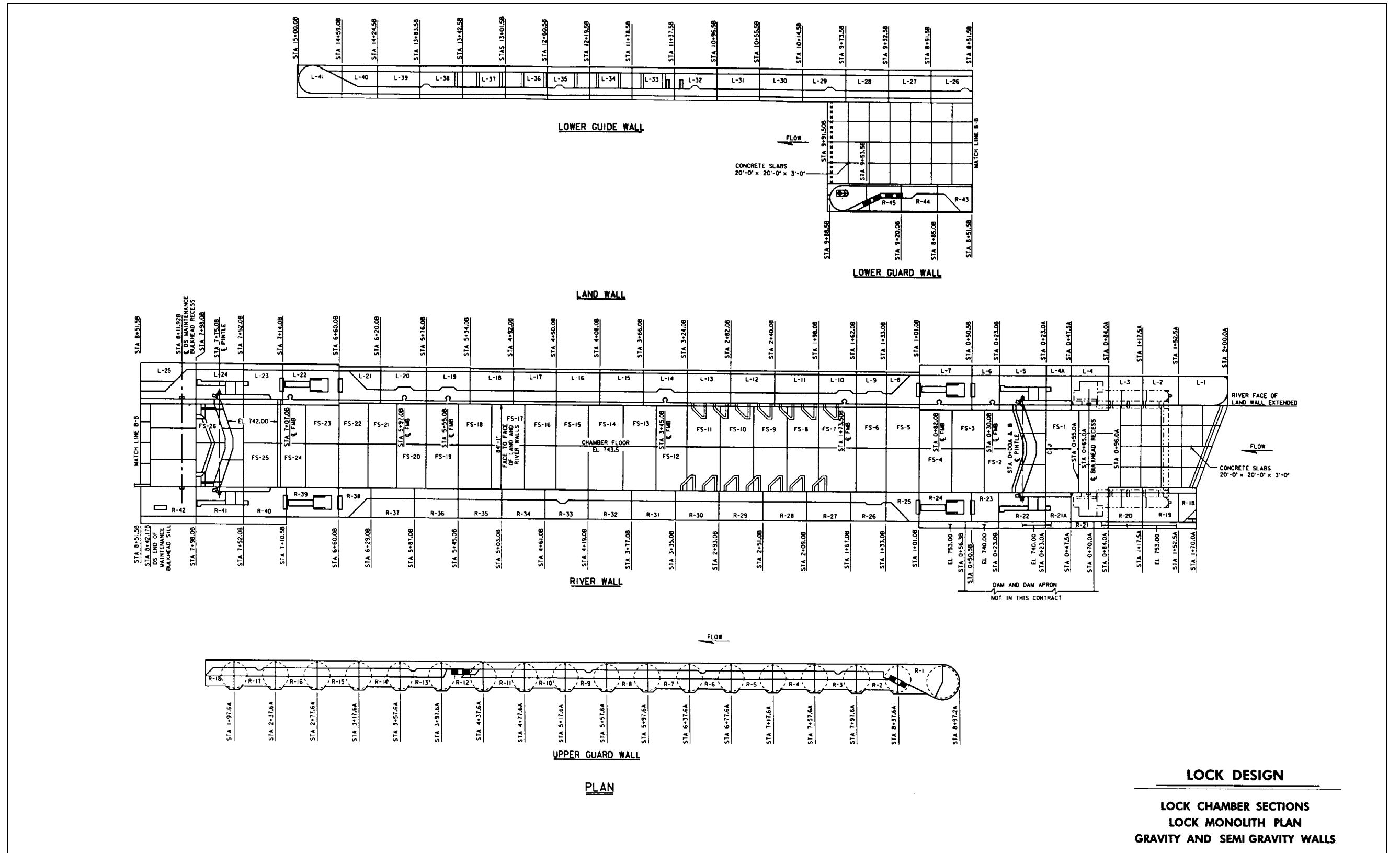

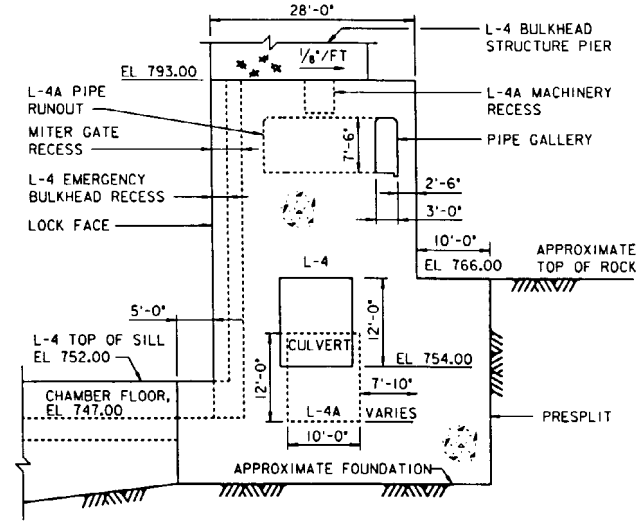

L-4 THRU L-4A

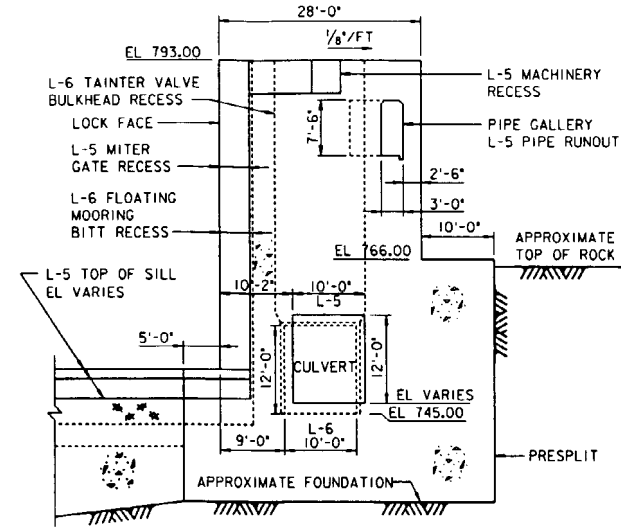

L-5 THRU L-6

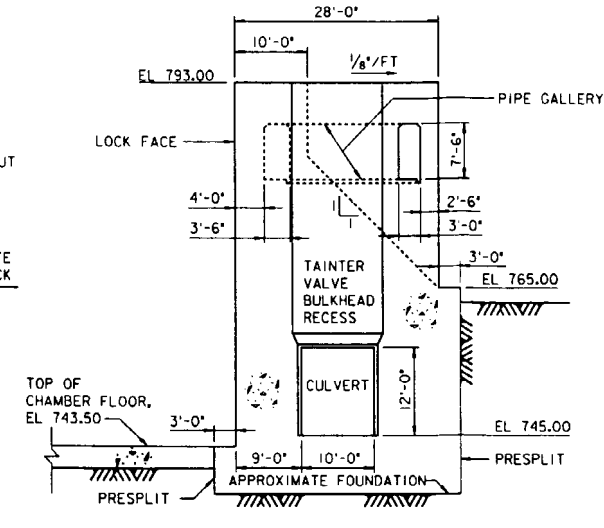

L-8

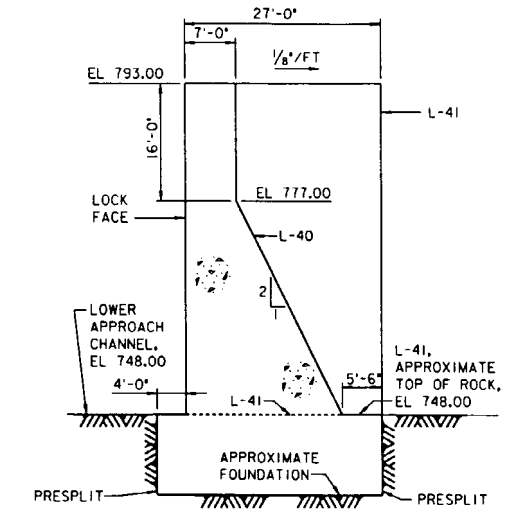

L-40 THRU L-41

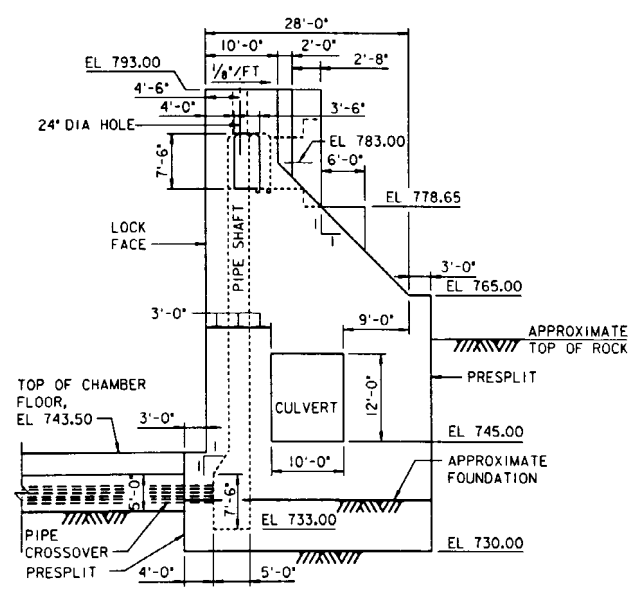

L-9

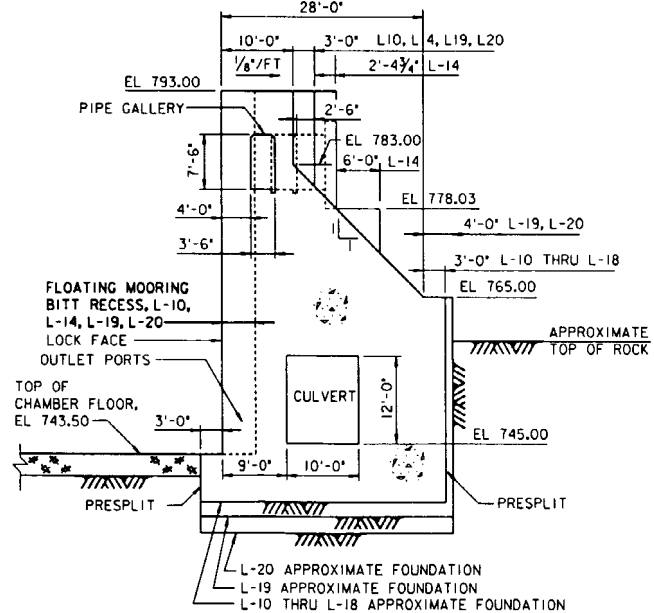

L-10 THRU L-20

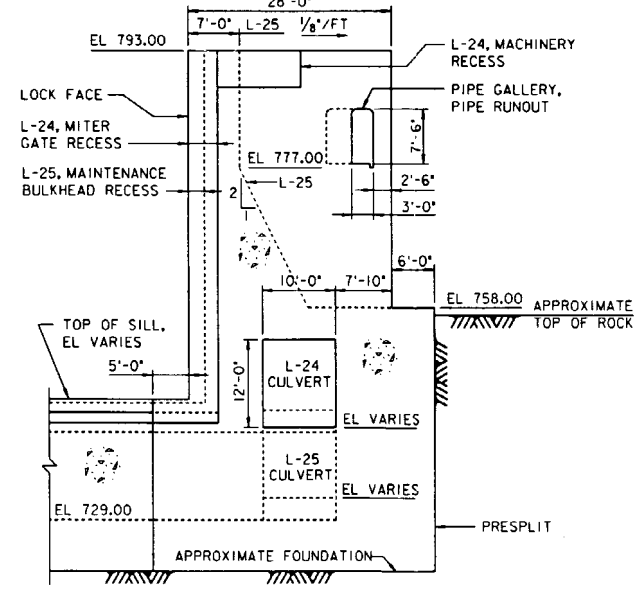

L-24 THRU L-25

LOCK DESIGN
LOCK CHAMBER SECTIONS
GRAVITY AND SEMI GRAVITY WALLS
LAND WALL SECTIONS

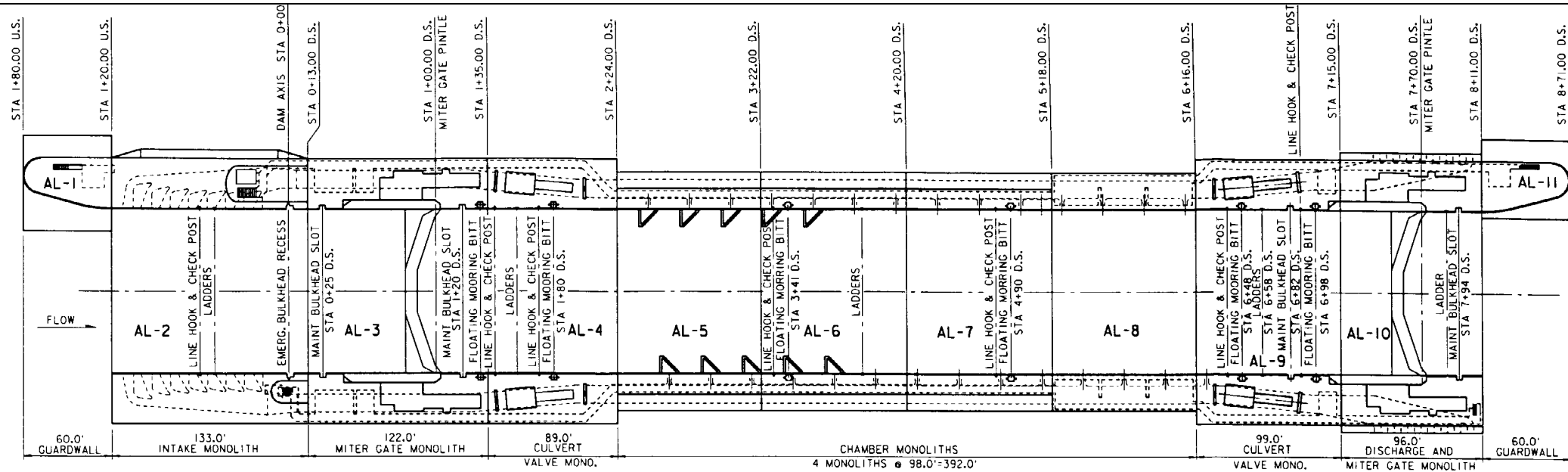

PLAN

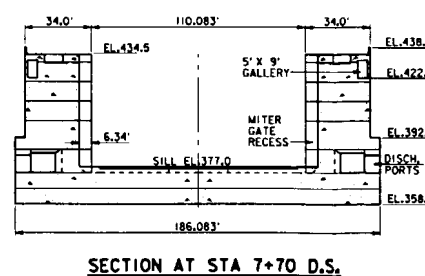
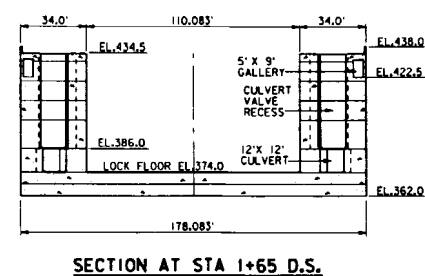
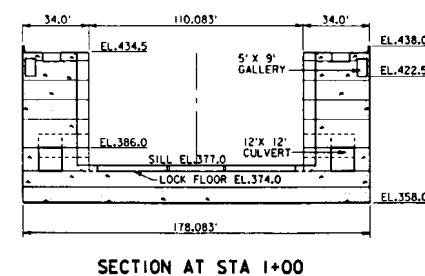
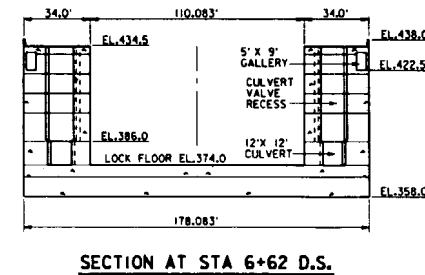
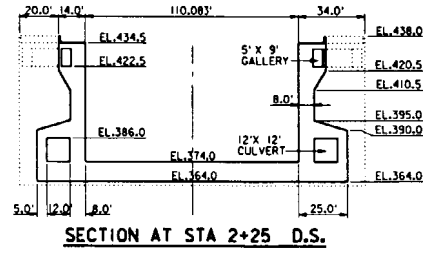
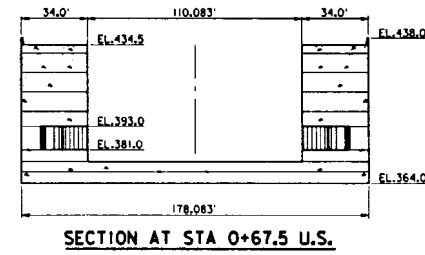

NOTES:
1. ALL CONCRETE LOCK MONOLITHS WILL BE FOUNDED ON STEEL H PILES

LOCK DESIGN
LOW LIFT NAVIGATION LOCK
CONCRETE "U" FRAME
110 FT X 600 FT LOCK CHAMBER
LOCK MONOLITH LAYOUT
PLAN AND SECTIONS

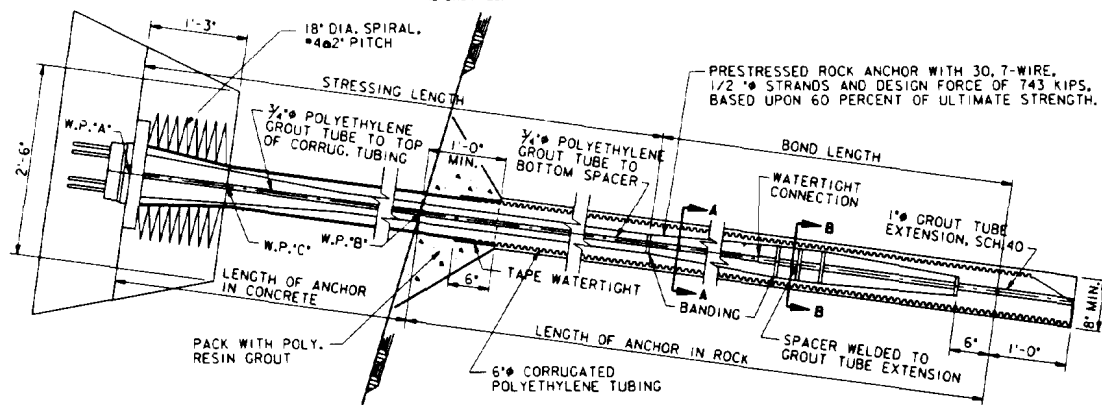
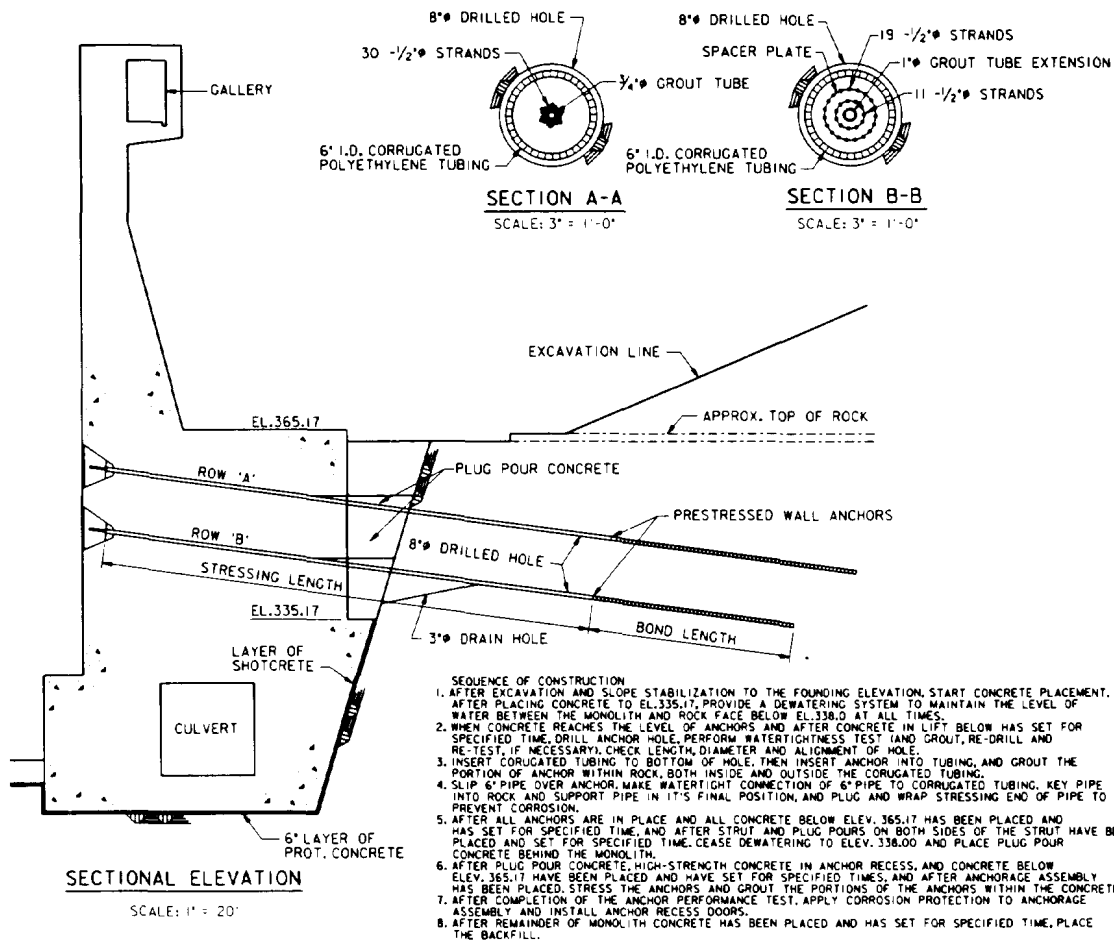

**TIE BACK CONCRETE WALL
(BAY SPRINGS LOCK)
ELEVATION AND SECTIONS**

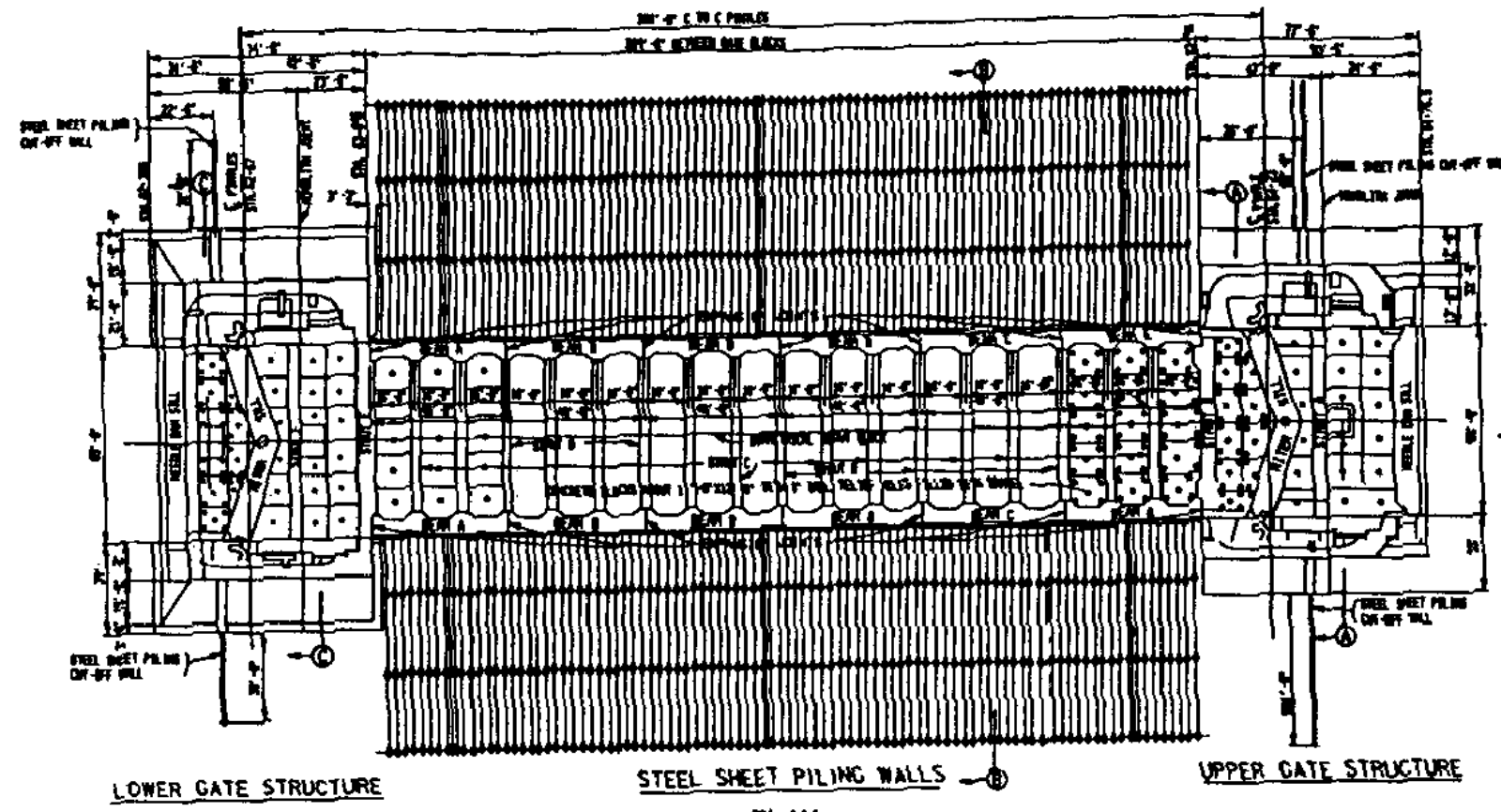

LOWER GATE STRUCTURE

STEEL SHEET PILING WALLS

UPPER GATE STRUCTURE

PLAN

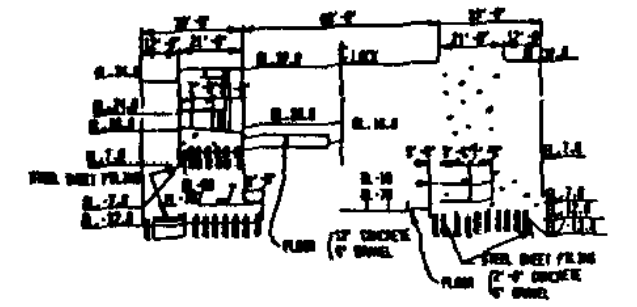

SECTION A-A

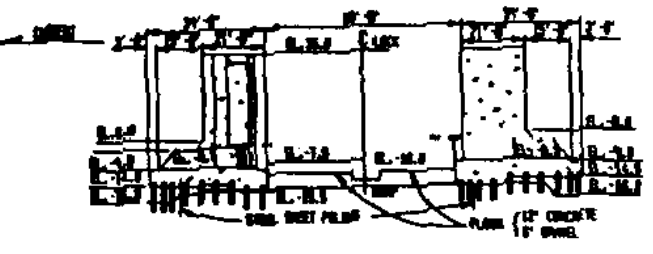

SECTION C-C

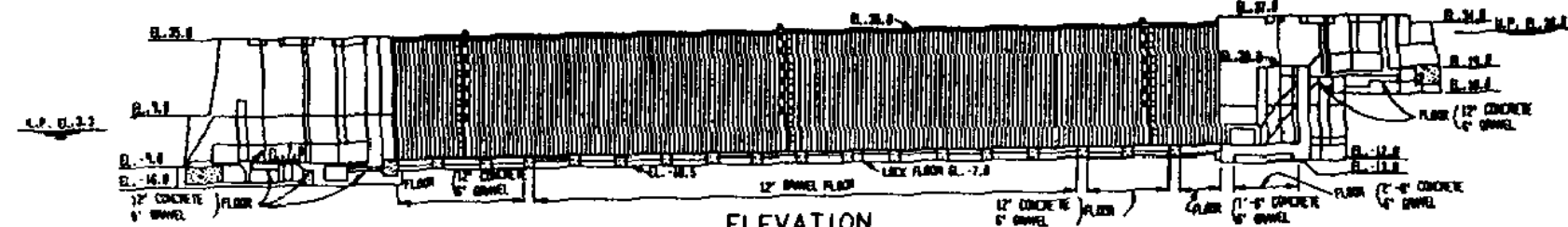

ELEVATION

AT CENTER LINE OF LOCK PILE WIDTH

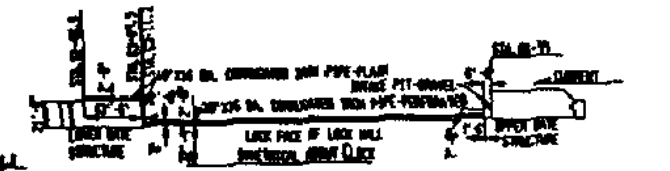

PLAN



PROFILE

LOCKWALL DRAIN PIPE

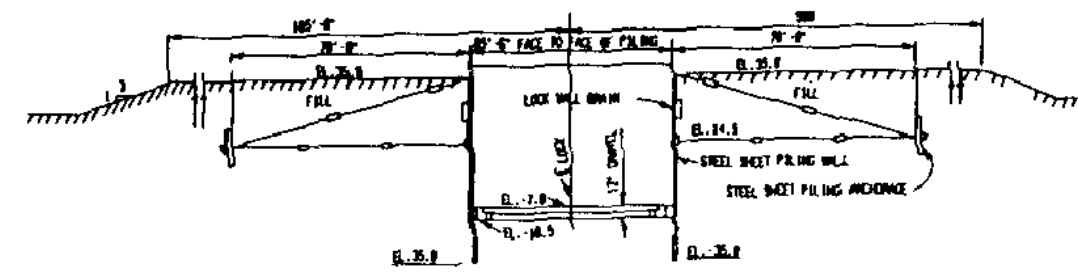

SECTION B-B

LOCK DESIGN

LOCK CHAMBER SECTIONS

SHEET PILE LOCK

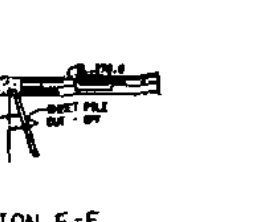
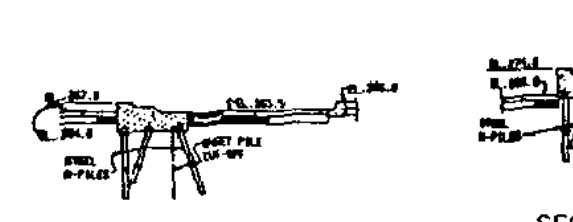
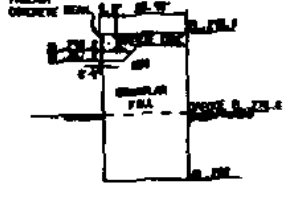
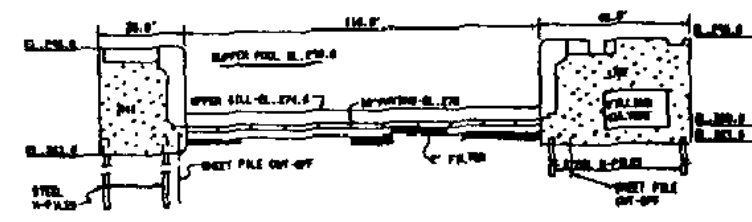
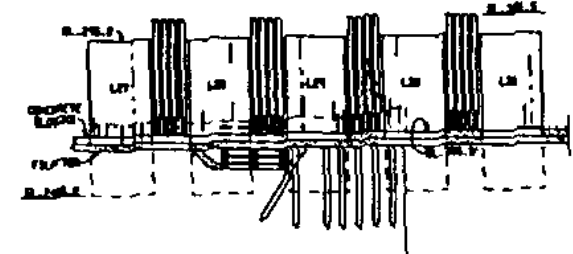
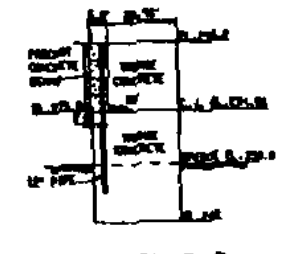
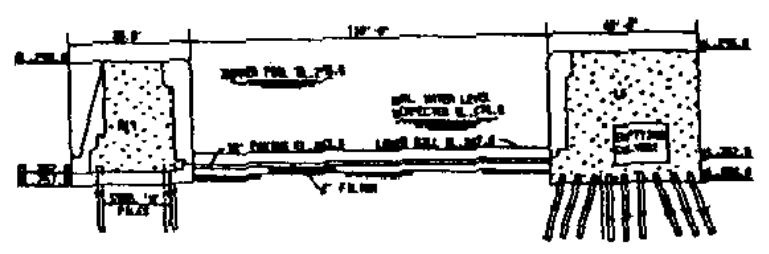
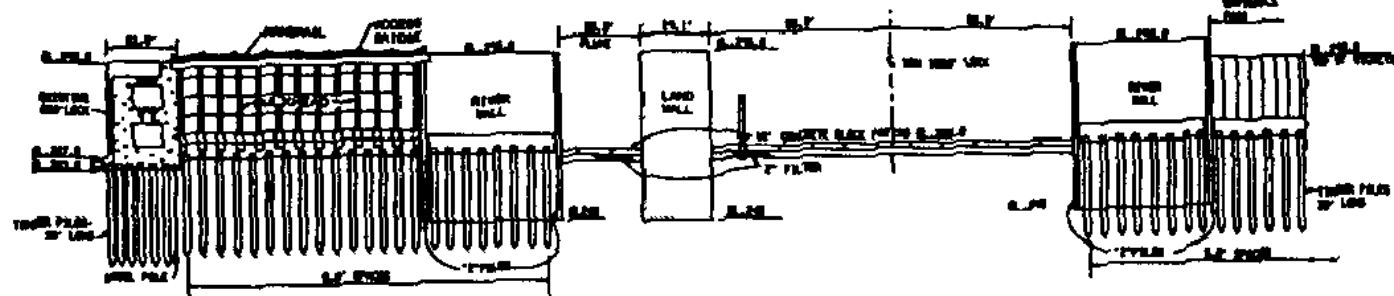
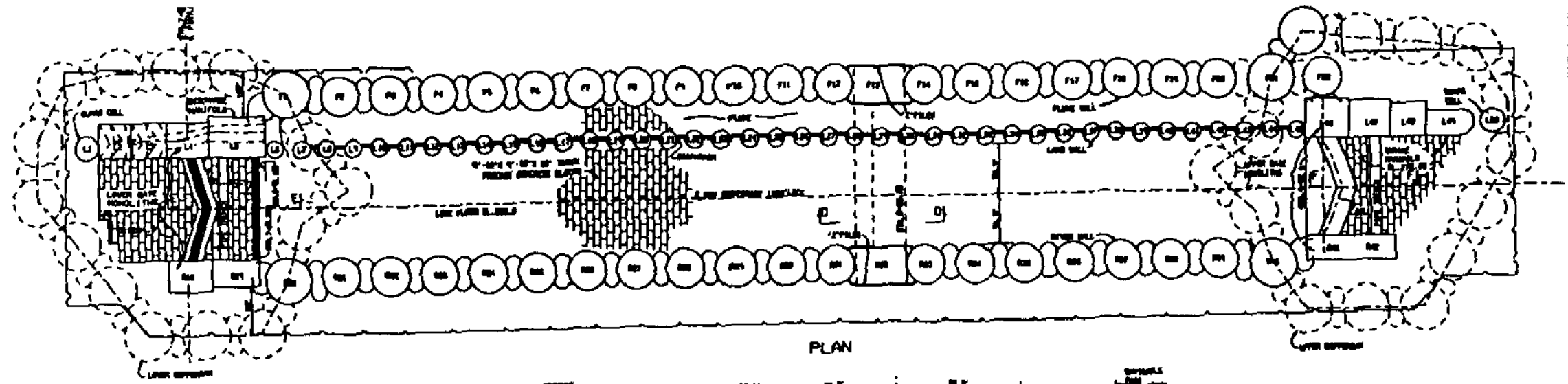

LOCK DESIGN
TEMPORARY SHEET PILE LOCK
LOCK 53 - OHIO RIVER
PLAN AND SECTIONS

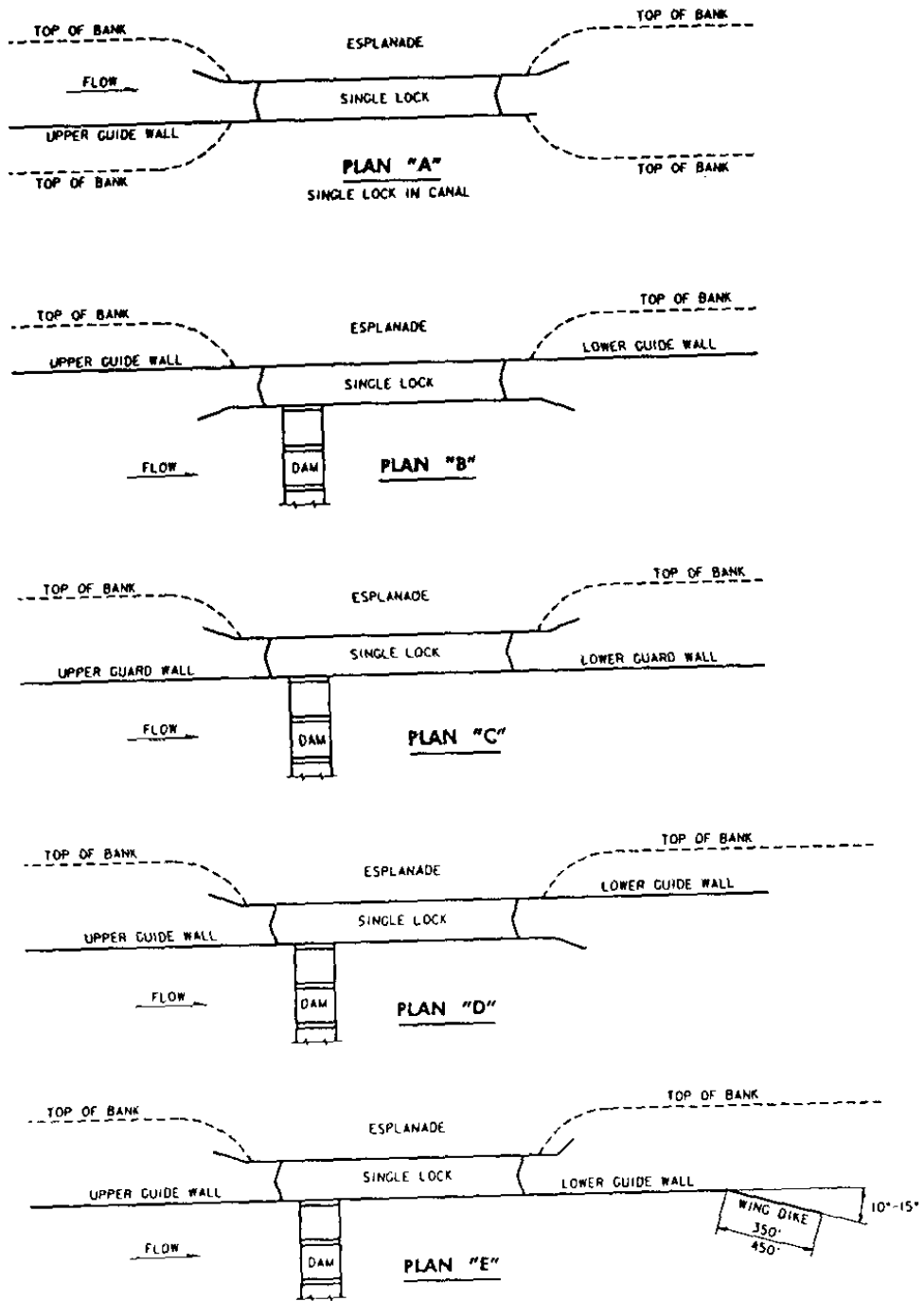

LOCK DESIGN

APPROACH WALLS
GENERAL LAYOUT
SINGLE LOCK PLANS

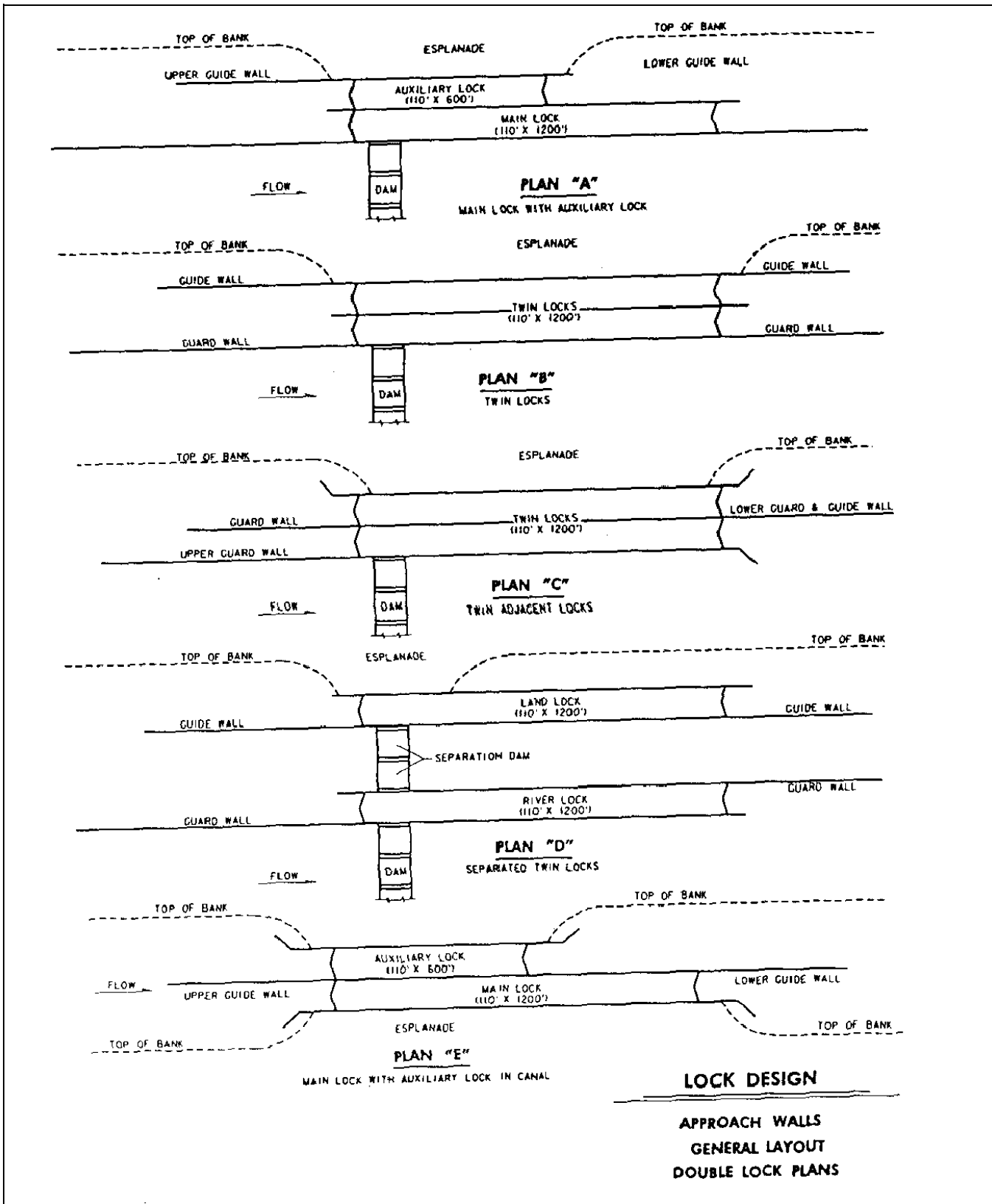

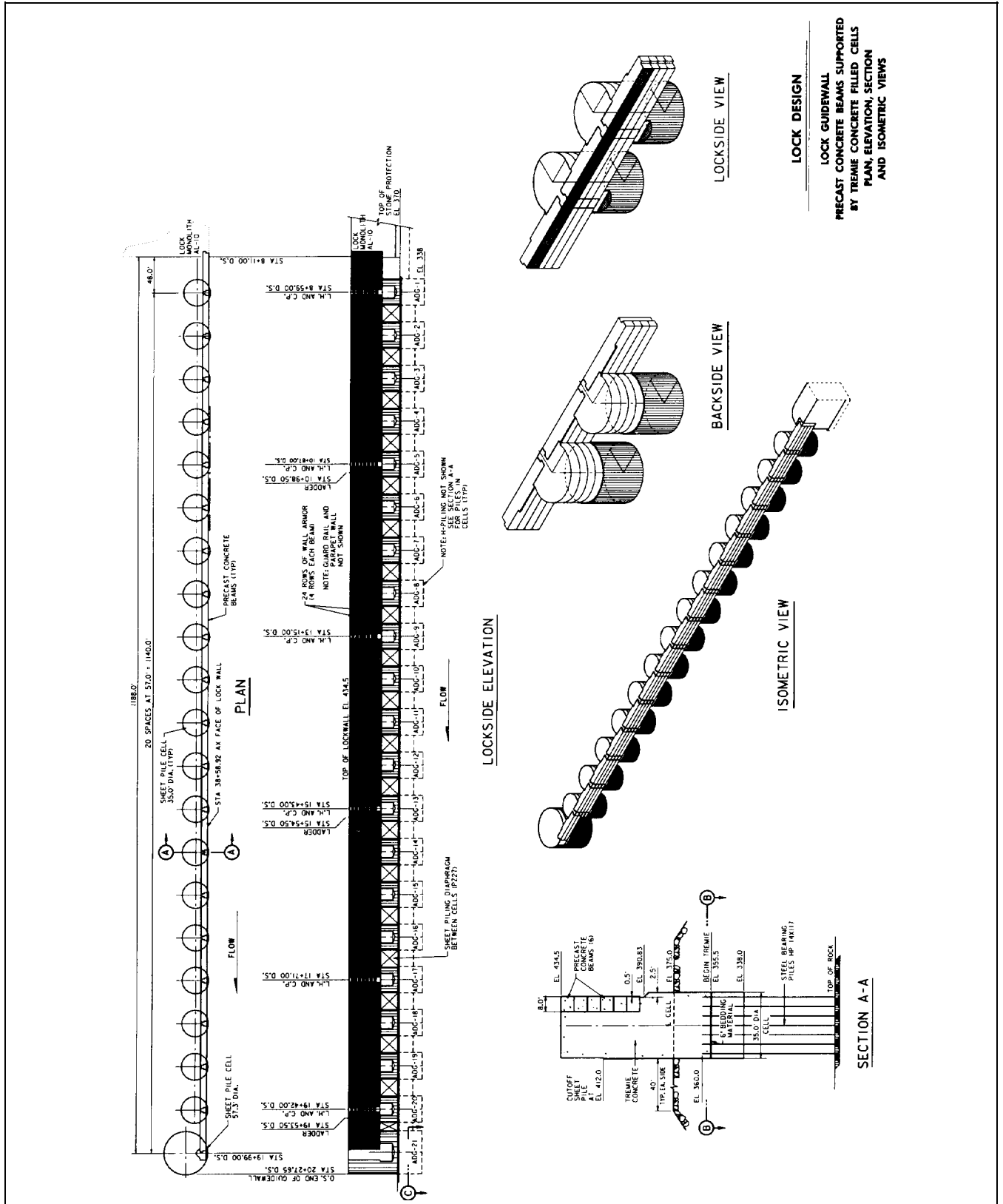

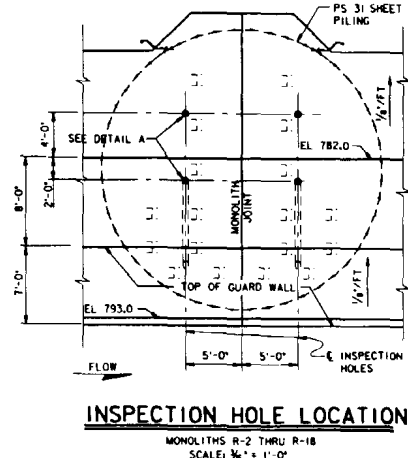
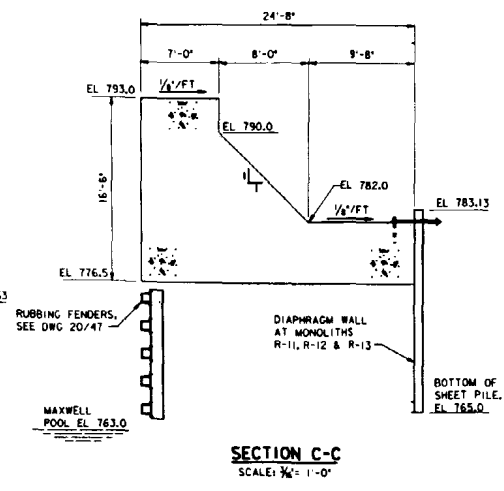
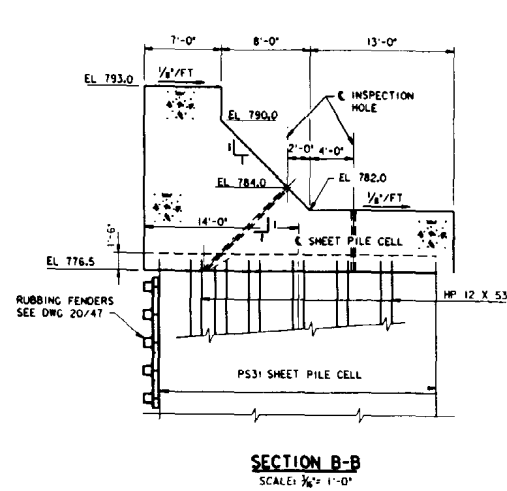
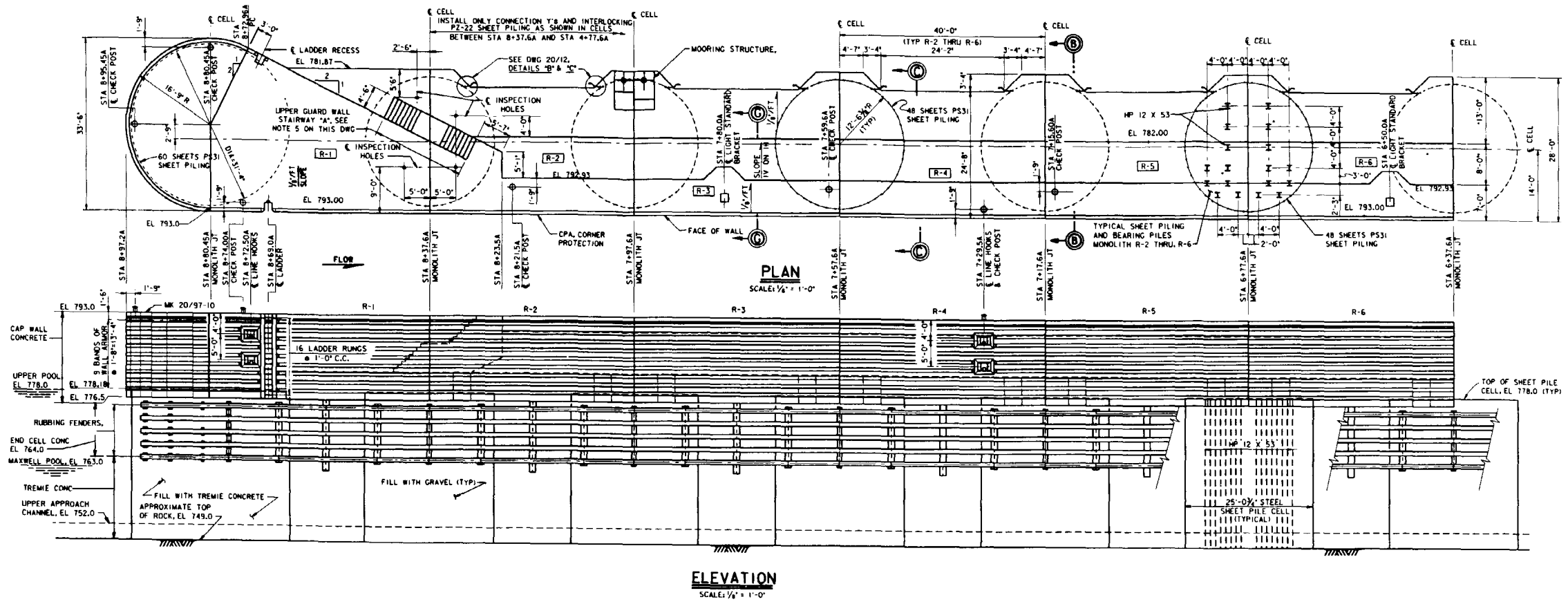

LOCK DESIGN

**APPROACH WALLS
GUIDEWALLS
CAST IN PLACE ON
TREMIE FILLED SHEET PILE CELLS**

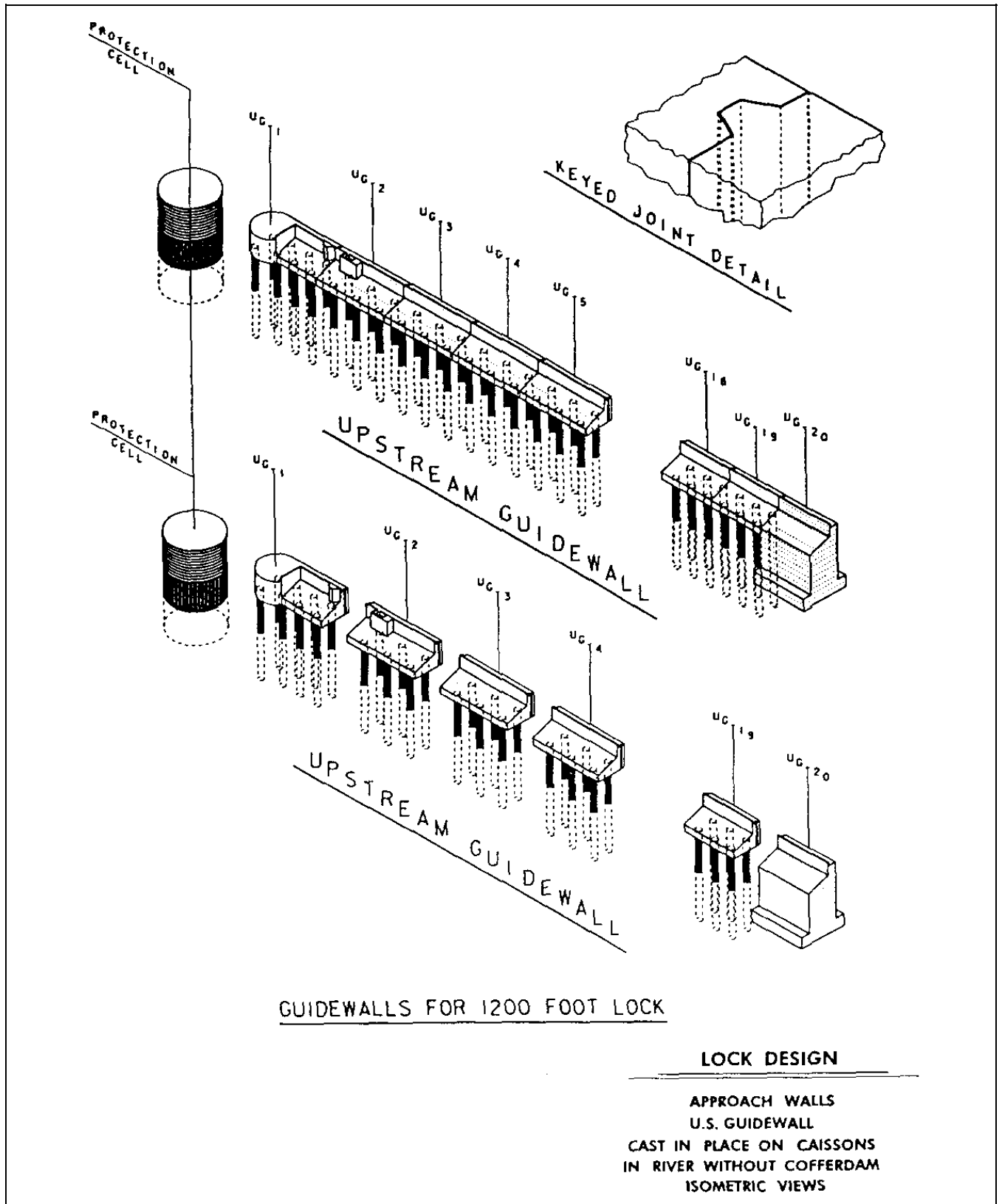

GUIDEWALLS FOR 1200 FOOT LOCK

LOCK DESIGN

- APPROACH WALLS
- U.S. GUIDEWALL
- CAST IN PLACE ON CAISSONS
- IN RIVER WITHOUT COFFERDAM
- ISOMETRIC VIEWS

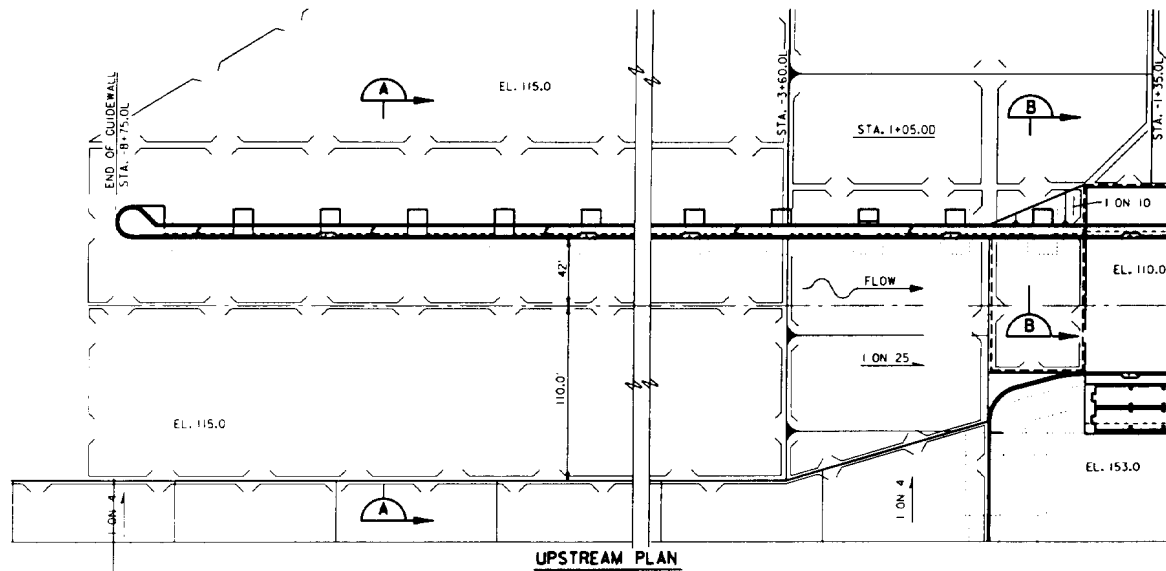

UPSTREAM PLAN

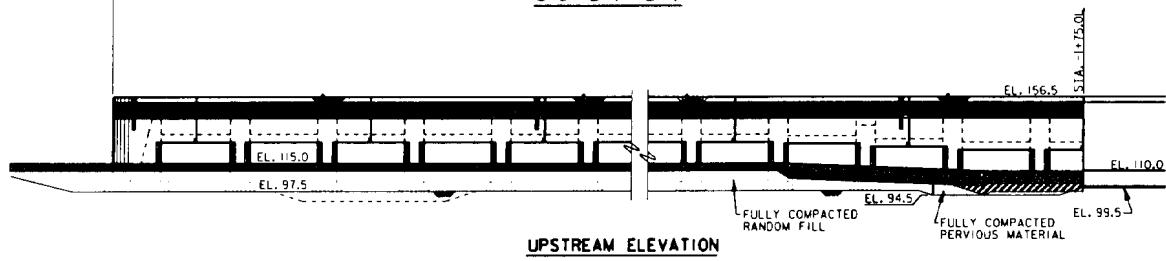

UPSTREAM ELEVATION

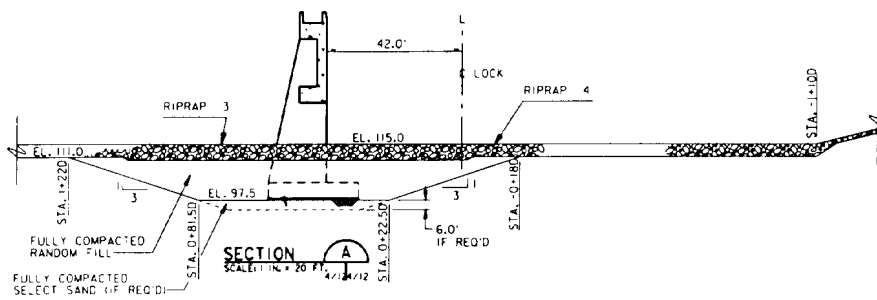

SECTION A

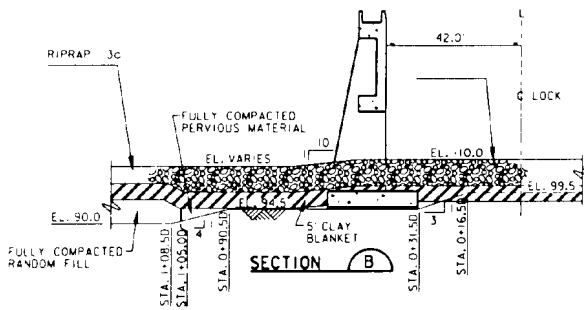

SECTION B

LOCK DESIGN

**LOCK APPROACH WALLS
CAST IN PLACE CONCRETE
DRY CONDITIONSX
UPSTREAM GUIDEWALL
PLAN, ELEVATION & SECTIONS**

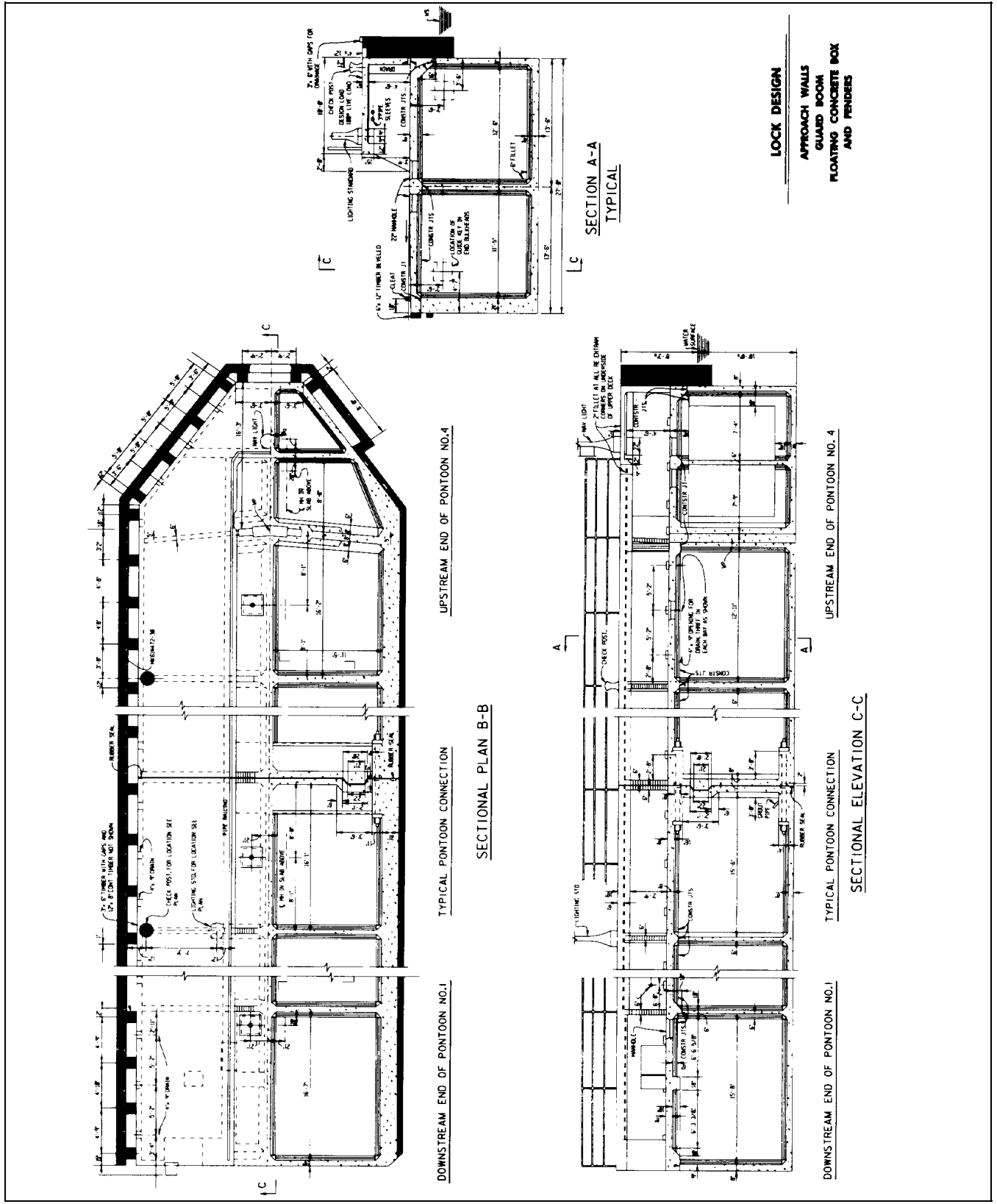

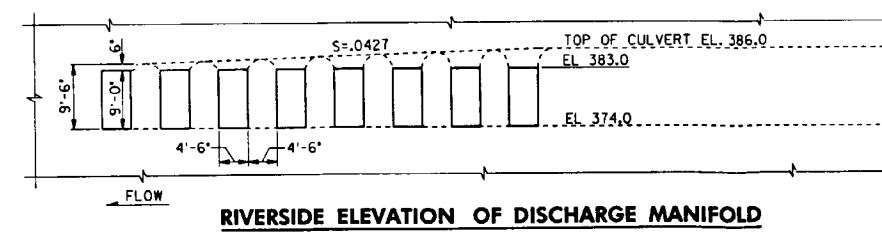
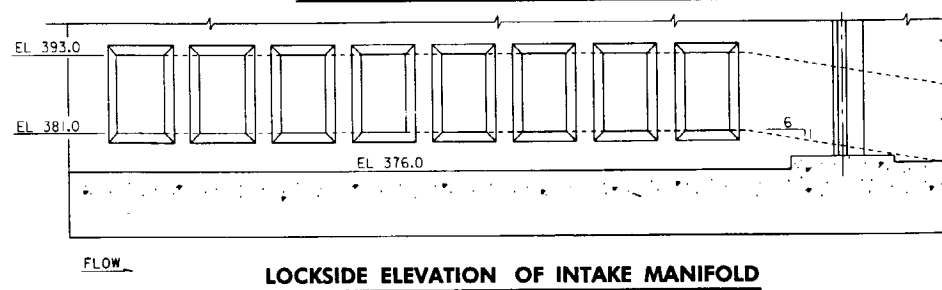
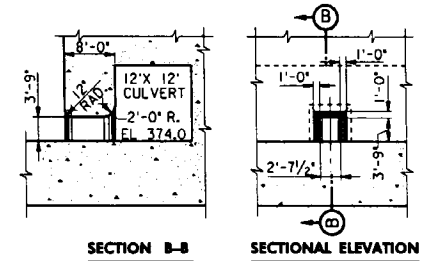
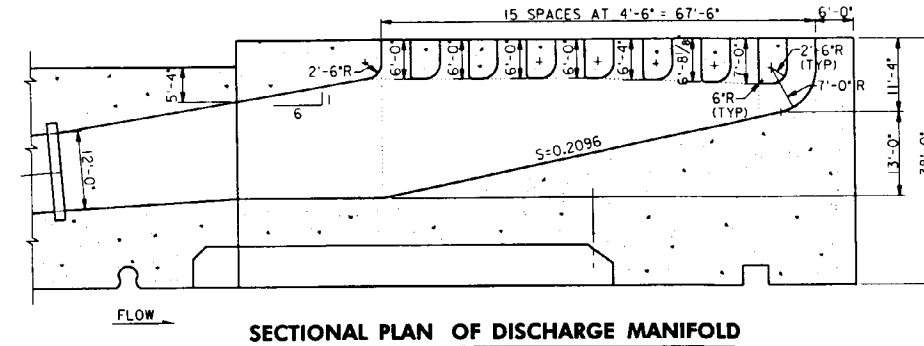
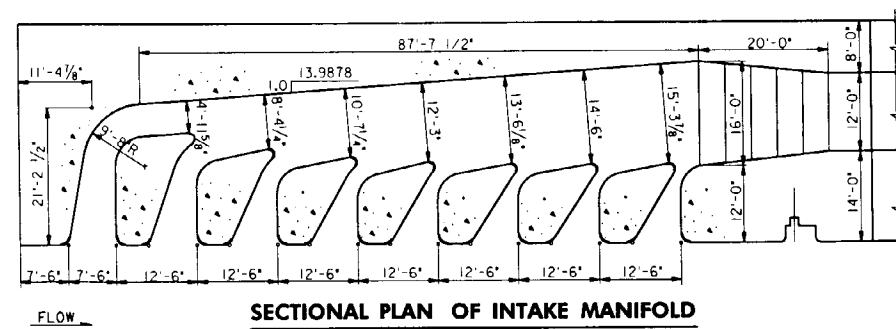
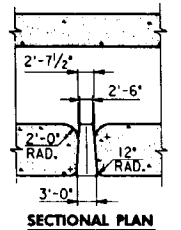
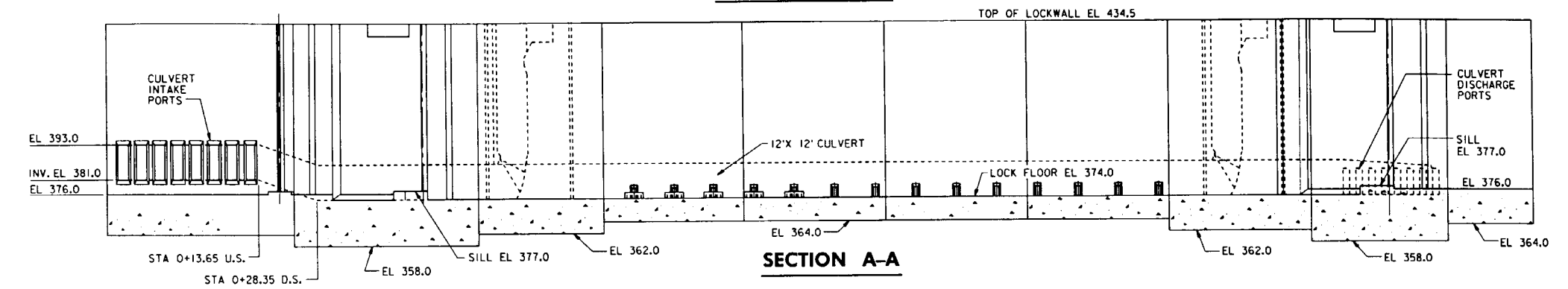
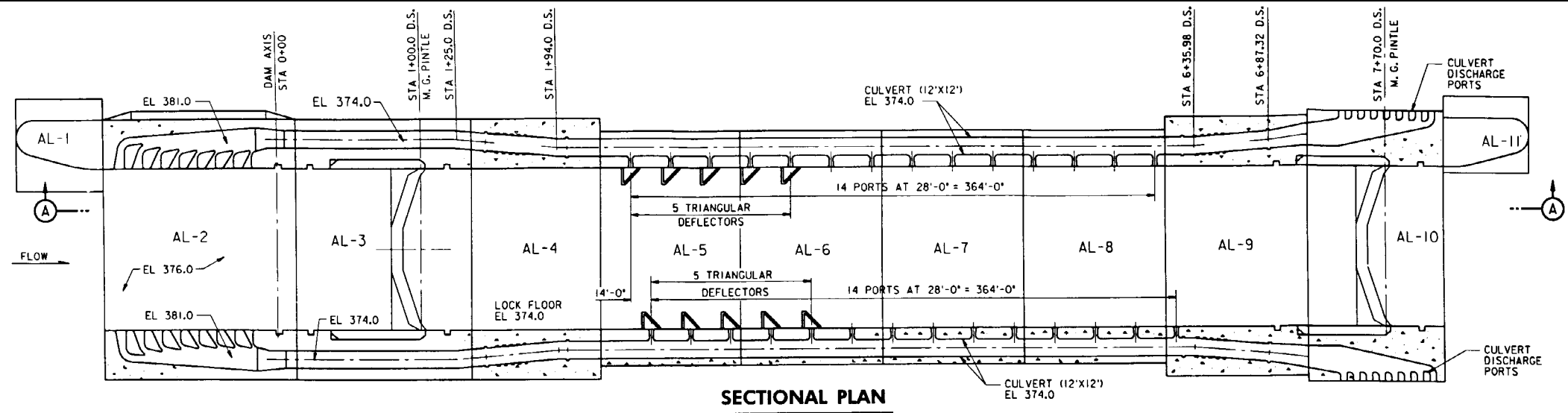

LOCK DESIGN

**LOCK FILLING & EMPTYING SYSTEMS
CHAMBER-SIDE PORT TYPE
600 FT. X 110 FT. LOW LIFT LOCK
SECTIONAL PLAN, ELEVATION,
MANIFOLD AND PORT DETAILS**

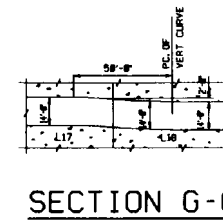
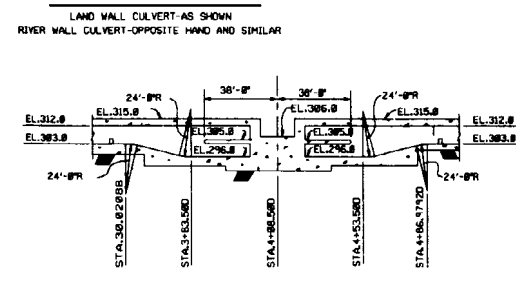
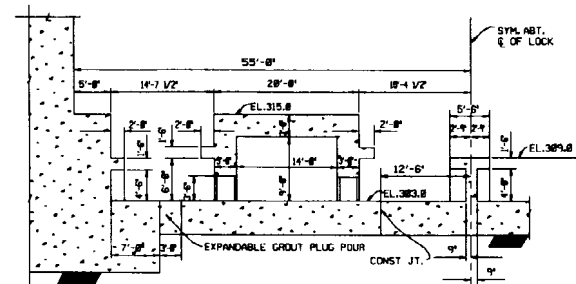
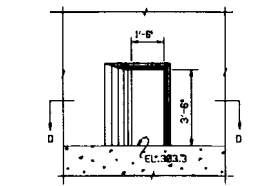
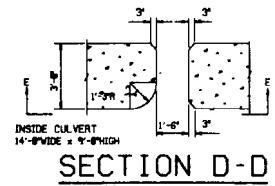
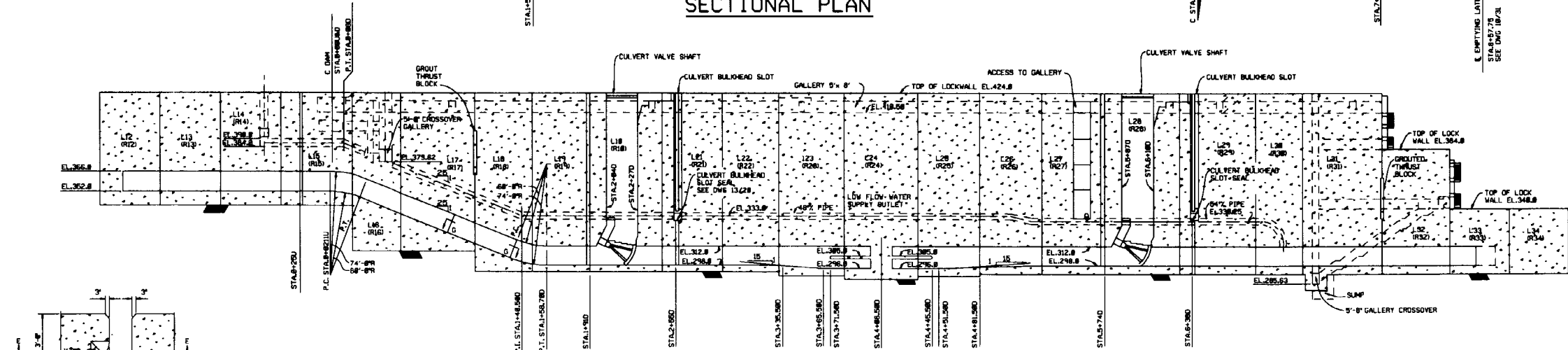
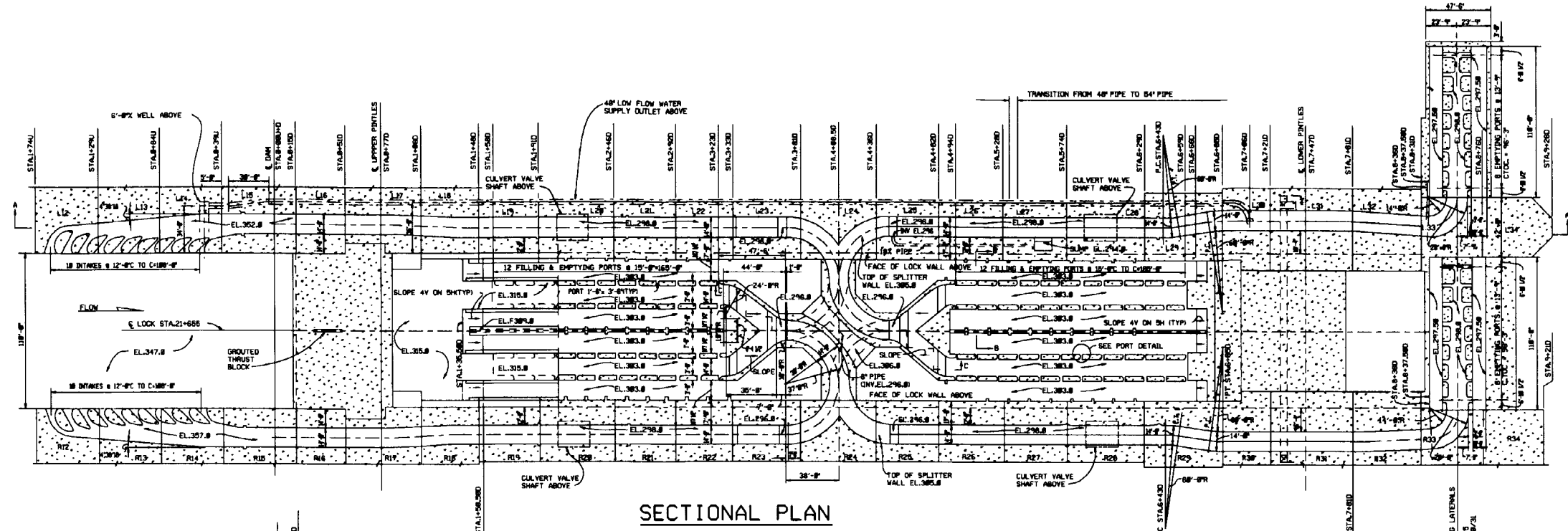

LOCK DESIGN
TYPES OF FILLING & EMPTYING SYSTEMS
CHAMBER
BOTTOM LONGITUDINAL TYPE
(BAY SPRINGS LOCK)

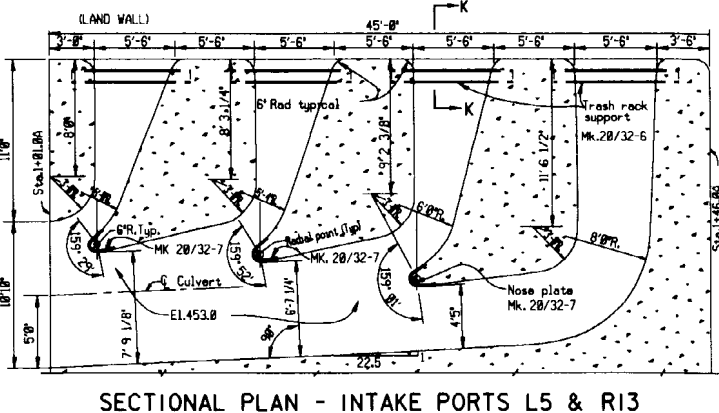
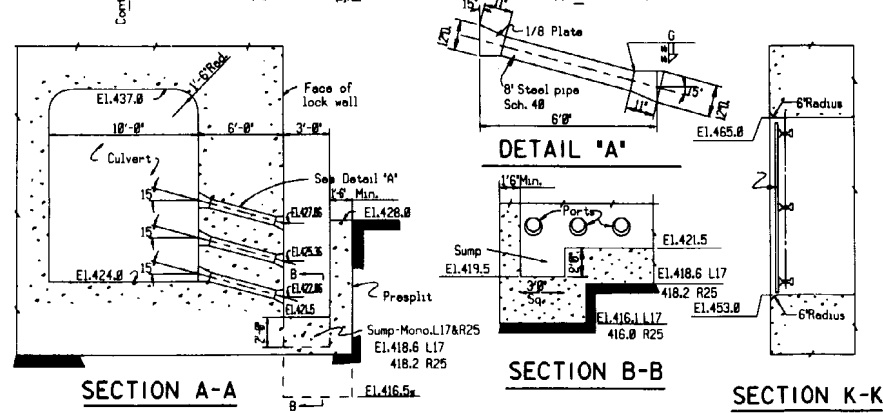
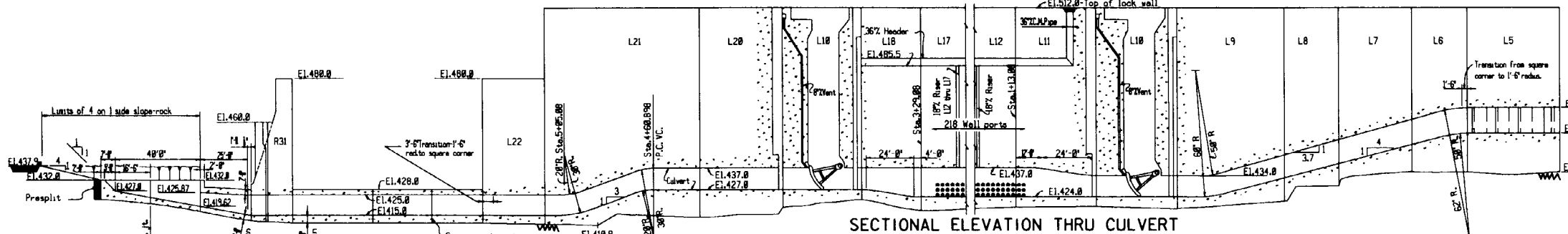
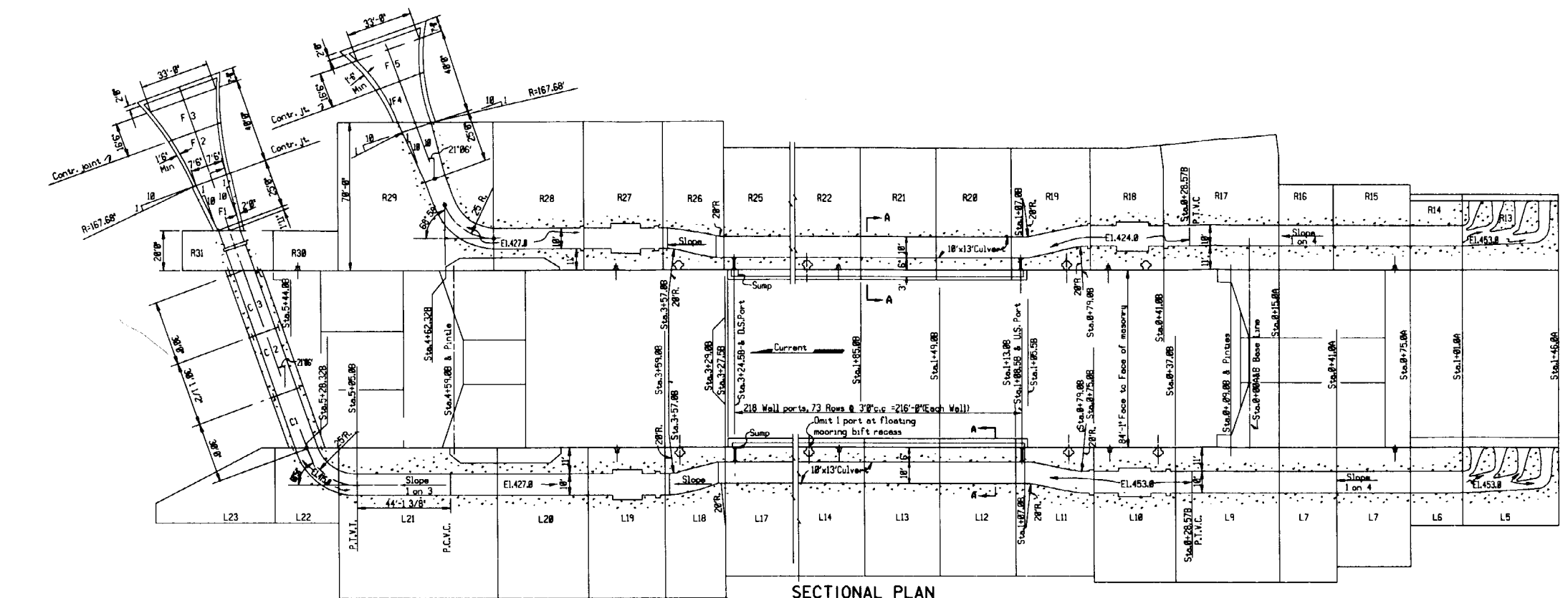

LOCK DESIGN
TYPES OF FILLING & EMPTYING SYSTEMS
MULTIPORT SYSTEM
(CORDELL HULL LOCK)

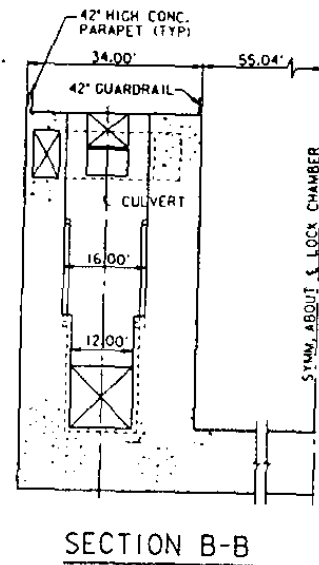
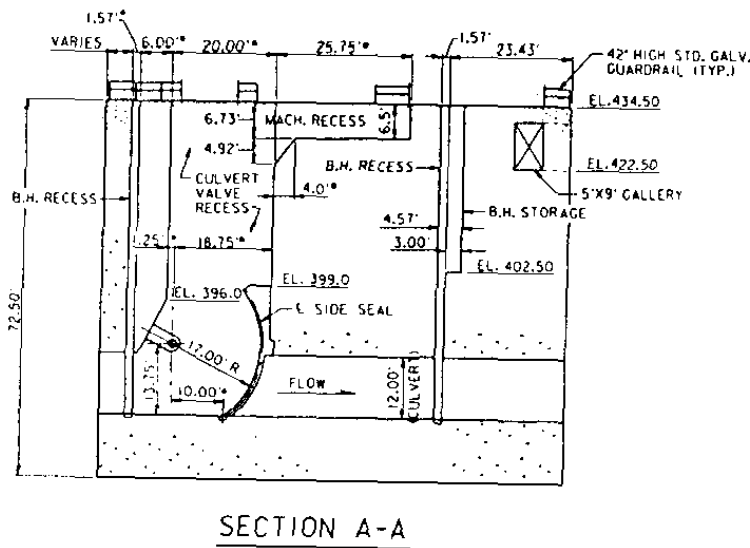
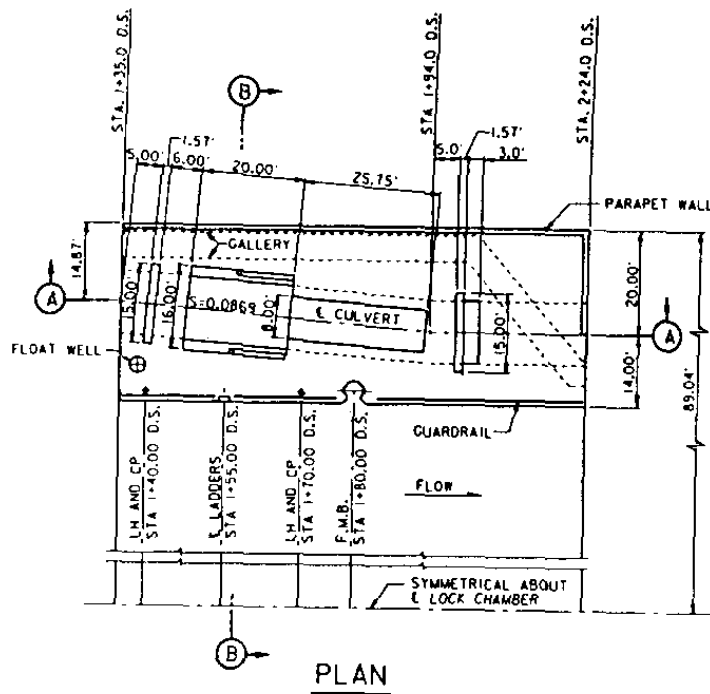

* DIMENSIONS MARKED WITH AN ASTERISK ARE ROTATED INTO VIEW FOR CLARITY.

LOCK DESIGN

LOW LIFT NAVIGATION LOCK
CONCRETE "U" FRAME
TYPICAL CULVERT VALVE MONOLITH
PLAN AND SECTIONS

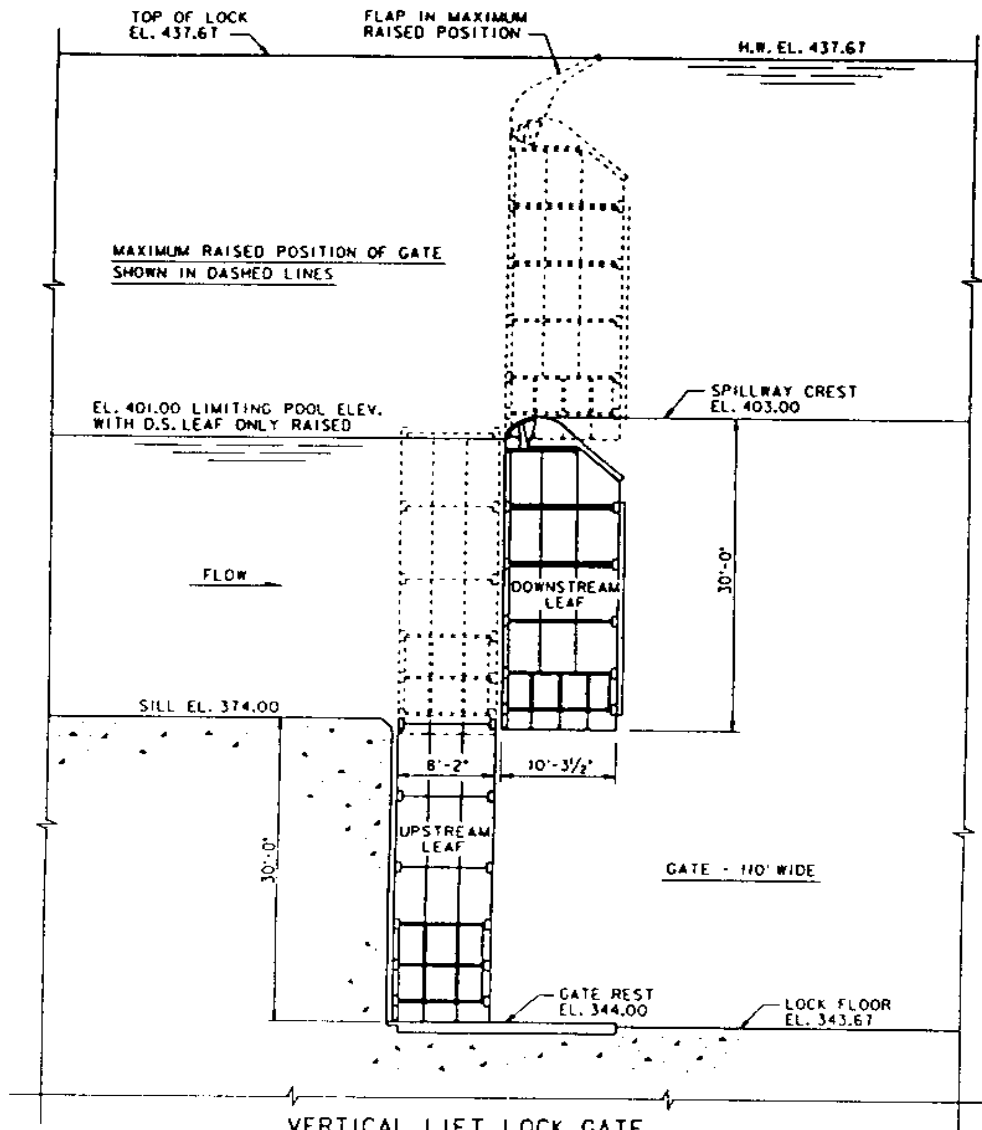

VERTICAL LIFT LOCK GATE
CHAIN OF ROCKS LOCKS
MISSISSIPPI RIVER

LOCK DESIGN

TYPES OF LOCK GATES & SILLS
LOW LIFT NAVIGATION LOCK
UPPER SILL WITH VERTICAL LIFT GATE

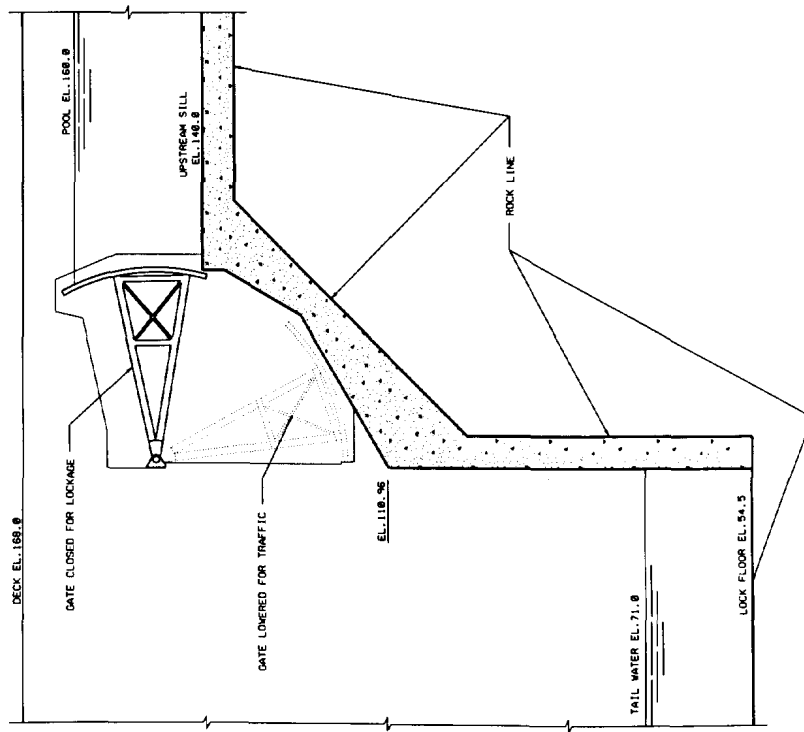
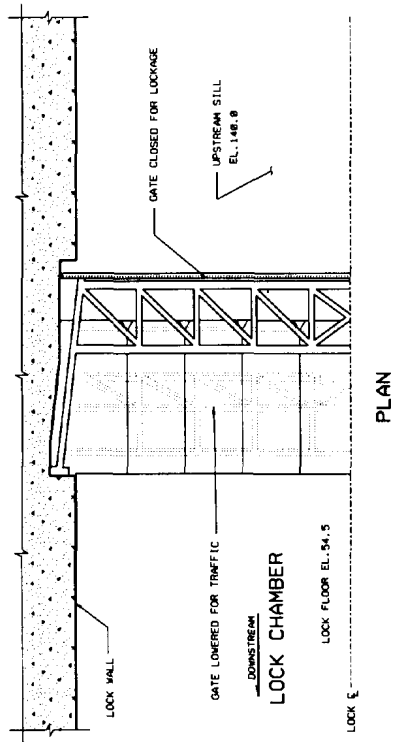

LOCK DESIGN

TYPES OF LOCK GATES AND SILLS
HIGH UPPER SILL - HIGH LIFT LOCK
SILL WITH TANNER GATE
UPPER GATE DELLE LOCK

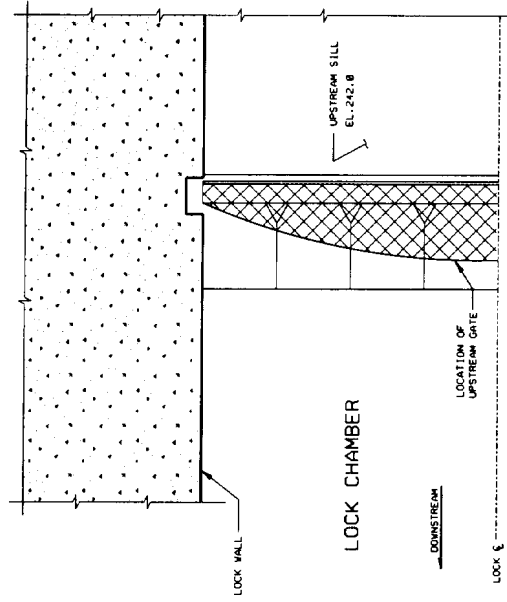

PLAN

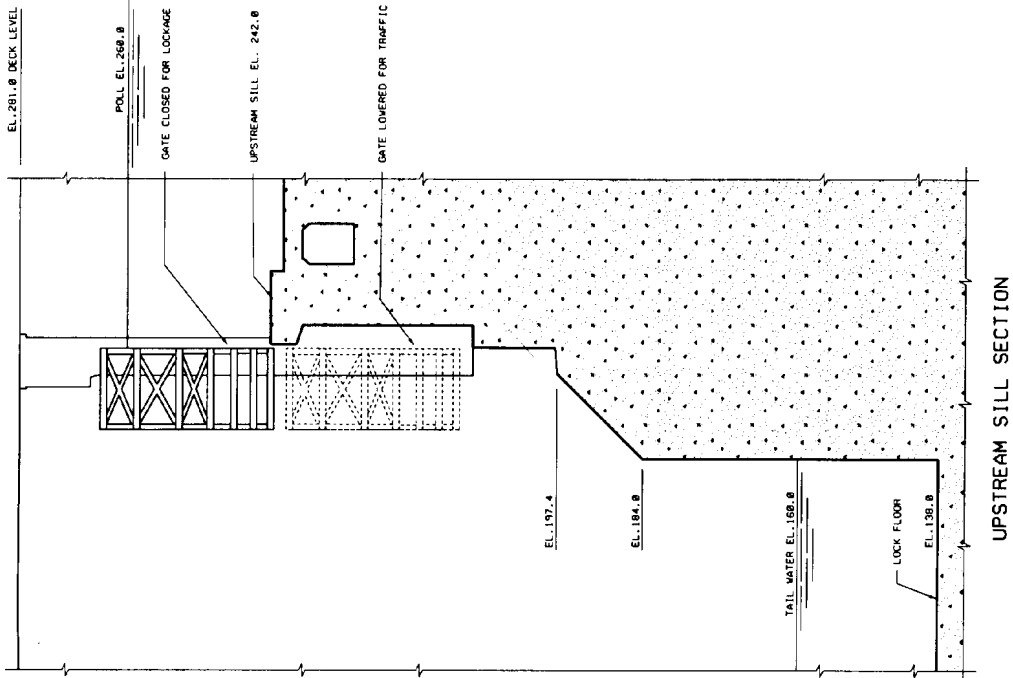

LOCK DESIGN

- TYPES OF LOCK GATES AND SILLS
- HIGH UPPER SILL - HIGH LIFT LOCK
- SILL WITH LIFT GATE
- UPPER GATE JOHN DAY LOCK

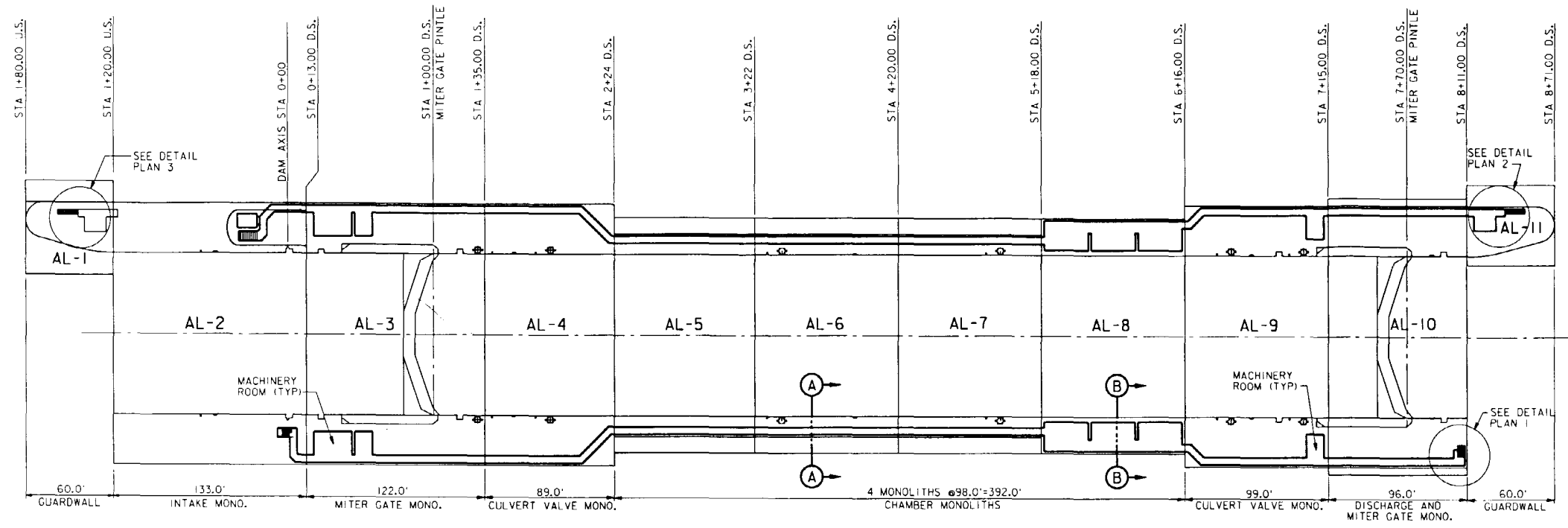

SECTIONAL PLAN THRU GALLERY

GALLERY PLAN

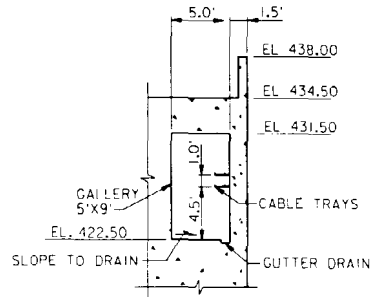

SECTION A-A

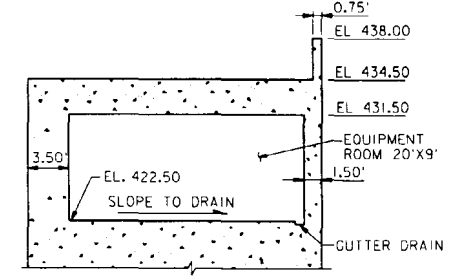

SECTION B-B

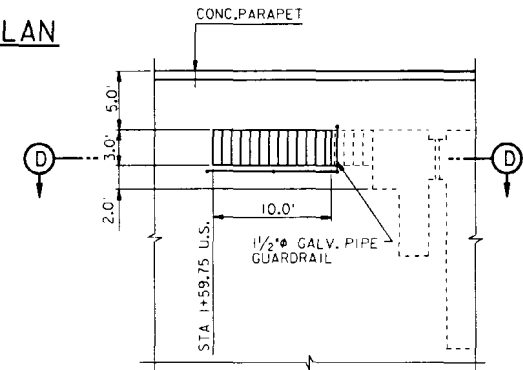

DETAIL PLAN 3

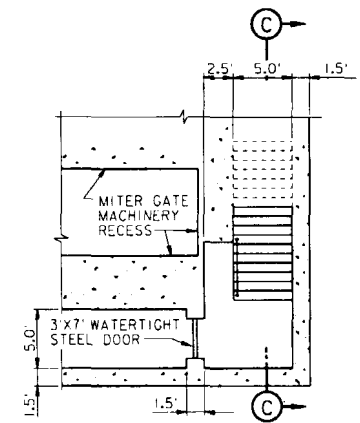

DETAIL PLAN 1

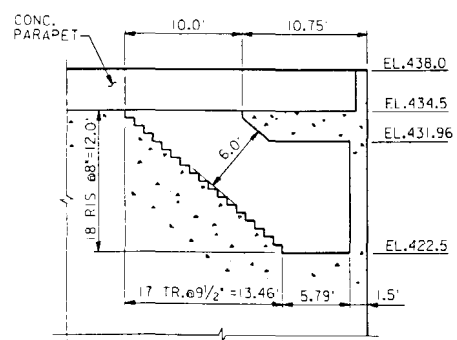

SECTION C-C

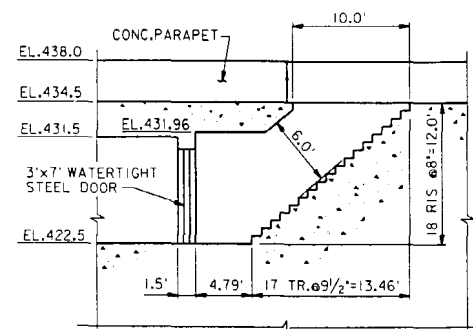

SECTION D-D

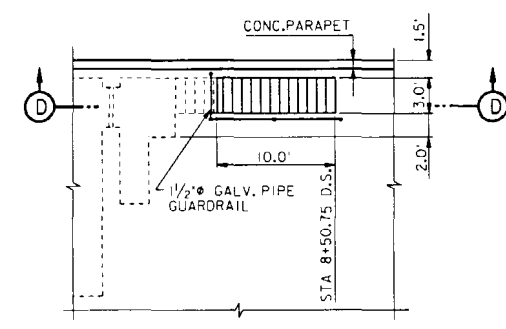

DETAIL PLAN 2

LOCK DESIGN

MISCELLANEOUS ACCESSORIES
EQUIPMENT GALLERY
110 FT. X 600 FT. LOCK
PLAN AND SECTIONS

Appendix A References

A-1. Required Publications

TM 5-809-1

Structural Design Criteria for Loads

ER 5-7-1 (FR)

Project Management

ER 200-2-2

Procedures for Implementing NEPA

ER 1105-2-100

Guidance for Conducting Civil Works Planning Studies

ER 1110-2-100

Periodic Inspection and Continuing Evaluation of Completed Civil Works Structures

ER 1110-2-1150

Engineering and Design for Civil Works Projects

ER 1110-2-1200

Plans and Specifications for Civil Works Projects

ER 1110-2-1404

Hydraulic Design of Deep Draft Navigation Projects

ER 1110-2-1457

Hydraulic Design of Small Boat Navigation

ER 1110-2-1458

Hydraulic Design of Shallow Draft Navigation Projects

ER 1110-2-1806

Earthquake Design and Analysis for Corps of Engineers Projects

ER 1110-2-8152

Planning and Design of Temporary Cofferdams and Braced Excavations

ER 1130-2-306

Navigation Lights, Aids to Navigation, Charts, and Related Data Policy, Practices and Procedures

EP 310-1-6A and 6B

Sign Standards Manual

EP 1165-2-1

Digest of Water Resources Policies

EM 385-1-1

Safety and Health Requirements Manual

EM 1110-1-1802

Geophysical Exploration

EM 1110-1-1804

Geotechnical Investigations

EM 1110-1-1904

Settlement Analysis

EM 1110-1-1905

Bearing Capacity of Soils

EM 1110-2-38

Environmental Quality in Design of Civil Works Projects

EM 1110-2-301

Guidelines for Landscape Planting at Floodwalls, Levees, and Embankment Dams

EM 1110-2-1202

Environmental Engineering for Deep-Draft Navigation Projects

EM 1110-2-1204

Environmental Engineering for Coastal Shore Protection

EM 1110-2-1205

Environmental Engineering for Local Flood Control Channels

EM 1110-2-1601

Hydraulic Design of Flood Control Channels

EM 1110-2-1604

Hydraulic Design of Navigation Locks

EM 1110-2-1605

Hydraulic Design of Navigation Dams

EM 1110-2-1610

Hydraulic Design of Lock Culvert Valves

EM 1110-2-1612

Ice Engineering

EM 1110-2-2602
30 Sep 95

EM 1110-2-2104
Strength Design for Reinforced-Concrete Hydraulic Structures

EM 1110-2-2200
Gravity Dam Design

EM 1110-2-2502
Retaining and Flood Walls

EM 1110-2-2503
Design of Sheet Pile Cellular Structures Cofferdams and Retaining Structures

EM 1110-2-2608
Navigation Locks - Fire Protection Provisions

EM 1110-2-2703
Lock Gates and Operating Equipment

EM 1110-2-2906
Design of Pile Foundations

EM 1110-2-4300
Instrumentation for Concrete Structures

ETL 1110-2-256
Sliding Stability for Concrete Structures

ETL 1110-2-310
Stability Criteria for Existing Concrete Navigation Structures on Rock Foundations

ETL 1110-2-321
Reliability Assessment of Navigation Structures, Stability of Existing Gravity Structures

ETL 1110-2-338
Barge Impact Analysis

ETL 1110-2-355
Structural Analysis and Design of U-Frame Lock Monoliths

ETL 1110-2-365
Nonlinear Incremental Structural Analysis of Massive Concrete Structures

ETL 1110-2-532
Reliability Assessment of Navigation Structures

ETL 1110-8-13 (FR)
Structural Engineering Responsibilities for Civil Works Projects

Computer Programs
Available from U.S. Army Engineer Waterways Experiment Station, Engineering Computer Programs Library, 3909 Halls Ferry Road, Vicksburg, MS 39180-6199.

CFRAME
Interactive Graphic Plane Frame Analysis

CSLIDE
Sliding Stability Analysis of Concrete Structures

CWFRAM
Analysis of Two-Dimensional U-Frame Structure

CBEAR
Bearing Capacity Analysis of Shallow Foundations

CPGA
Pile Group Analysis Program - Rigid Base Method

DSAD
Interactive Graphic Three-dimensional Stability Analysis/Design Program

SOILSTRUCT
Soil-Structure Interaction Program

A-2. Related Publications

Note: Related publications used in this EM are available on interlibrary loan from the Research Library, ATTN: CEWES-IM-MI-R, U.S. Army Engineer Waterways Experiment Station, 3909 Halls Ferry Road, Vicksburg, MS 39180-6199.

American Association of State Highway and Transportation Officials (AASHTO)
American Association of State Highway and Transportation Officials (AASHTO). "Standard Specifications for Highway Bridges."

American Concrete Institute (ACI) 1981
American Concrete Institute (ACI). 1981. "Control of Cracking in Concrete Structures," ACI 224 R-80.

American Society for Testing Materials (ASTM) 1990
American Society for Testing Materials (ASTM). 1990. "Standard Test Method for Classification of Soils for Engineering Purposes," *Book of ASTM Standards*.

Bloor 1951

Bloor, R. L. 1951. "Lock Sizes for Inland Waterways," *Transactions of the American Society of Civil Engineers*, Vol 116.

Clough and Duncan 1969

Clough, G. W., and Duncan, J. M. 1969. "Finite Element Analysis of Port Allen and Old River Locks," Contract Report S-69-6, U.S. Army Engineer Waterways Experiment Station, Vicksburg, MS.

Coastal Engineering Research Center 1984

Coastal Engineering Research Center. 1984. *Shore Protection Manual (SPM)*, Vol 11.

Davis 1989

Davis, J. P. 1989. "Hydraulic Design of Navigation Locks," Miscellaneous Paper HL-89-5, U.S. Army Engineer Waterways Experiment Station, Vicksburg, MS.

Duncan, Clough, and Ebeling 1990

Duncan, J. M., Clough, G. W., and Ebeling, R. M. 1990. "Behavior and Design of Gravity Earth Retaining Structures," American Society of Civil Engineers conference on the *Design and Performance of Earth Retaining Structures*, Cornell, NY.

Ebeling 1990

Ebeling, R. M. 1990. "Review of Finite Element Procedures for Earth Retaining Structures," Miscellaneous Paper ITL-90-5, U.S. Army Engineer Waterways Experiment Station, Vicksburg, MS.

Ebeling et al. 1992 (Mar)

Ebeling, R. M., Clough, G. W., Duncan, J. M., and Brandon, T. L. 1992 (Mar). "Methods of Evaluating the Stability and Safety of Gravity Earth Retaining Structures Founded on Rock," Technical Report REMR CS-29, U.S. Army Engineer Waterways Experiment Station, Vicksburg, MS.

Ebeling, Duncan, and Clough 1990 (Oct)

Ebeling, R. M., Duncan, J. M., and Clough, G. W. 1990 (Oct). "Method of Evaluating the Stability and Safety of Gravity Earth Retaining Structures Founded on Rock - Phase 2 Study" Technical Report ITL-90-7, U.S. Army Engineer Waterways Experiment Station, Vicksburg, MS.

Ebeling et al. 1992 (Oct)

Ebeling, R. M., Mosher, R. M., Abraham, K., and Peters, J. F. 1992 (Oct). "Soil Structure Interaction Study of Red River Lock and Dam No. 1 Subjected to Sediment Loading," Technical Report ITI-93-2, U.S. Army Engineer Waterways Experiment Station, Vicksburg, MS.

Ebeling, Peters, and Clough 1992 (May)

Ebeling, R. M., Peters, J. F., and Clough, G. W. 1992 (May). "Users Guide for the Incremental Construction, Soil-Structure Interaction Program SOILSTRUCT, Technical Report ITL-90-6, U.S. Army Engineer Waterways Experiment Station, Vicksburg, MS.

Filz and Duncan 1992 (Apr)

Filz, G. M., and Duncan, J. M. 1992 (Apr). "An Experimental and Analytic Study of Earth Loads on Rigid Retaining Walls," U.S. Army Engineer Waterways Experiment Station, Virginia Polytechnic Institute and State University, Blacksburg, VA.

Hilmer 1986

Hilmer, K. 1986. "Evaluation of a Ten-Year Measuring Program at the Eibach Lock."

Institute for Water Resources 1988

Institute for Water Resources. 1988. IWR 88-R-7.

Institute for Water Resources 1992

Institute for Water Resources. 1992. "Guidelines for Risk and Uncertainty Analysis in Water Resources Planning," IWR 92-R-1.

A-3. Bibliography

American Concrete Institute (ACI) 1983

American Concrete Institute (ACI). 1983. "Building Code Requirements for Reinforced Concrete," ACI 318-83.

American Institute of Steel Construction (AISC) 1980

American Institute of Steel Construction (AISC). 1980. "Manual of Steel Construction," 8th edition.

American Welding Society (AWS) 1988

American Welding Society (AWS). 1988. "Structural Welding Code," AWS D1-1-88.

Ferguson 1981

Ferguson, P. M. 1981. *Reinforced Concrete Fundamentals*, 4th edition, Wiley, New York.

EM 1110-2-2602
30 Sep 95

Timoshenko and Woinowsky-Krieger 1959

Timoshenko and Woinowsky-Krieger. 1959. *Theory of Plates and Shells*, 2nd edition, McGraw-Hill, New York.

Appendix B Wall Loadings - Check Lists

B-1. Introduction

After the amount or intensity of the individual loads acting on lock walls or monoliths have been determined as separate considerations, the possible combinations of such loads that will determine the most adverse condition must be established. Conditions and combinations of loadings that will ordinarily require examination are described below. These loads should be combined appropriately to determine the critical conditions for stability and wall stresses. However, independent checks of each structure under consideration should be made to determine whether these conditions are adequate for determination of the most critical loading.

B-2. General Design Loading Conditions

a. Usual. This case is the normal operating condition and should account for the most severe loads during a complete lockage cycle and for the most severe stability requirements experienced during normal conditions.

b. Unusual. Under these conditions, the design should account for unusual loads that can occur at normal lock sites, such as vessel impact, unusual saturation levels, scheduled pool drawdowns, low-water levels, planes, ice thrusts, wind loads, and operating basis earthquakes. The unwatered condition of the lock is also considered in this case with loads corresponding with expected water levels and uplift conditions. Construction conditions are also considered an unusual load case. Under these conditions, full earth load, moist or saturated, with or without uplift, according to construction plans, possible use as part of a cofferdam, and all construction surcharge loads should be considered.

c. Extreme. The occurrence of very unlikely events, such as a probable maximum flood (PMF) or maximum credible earthquake (MCE), should be considered extreme.

B-3. Design Loading for Stability - Lock Chamber Land Walls

a. Case 1 - normal operating condition (usual). The requirements are as follows:

- (1) Backfill to a predetermined height.
- (2) Saturation line to an assumed level.

- (3) Surcharge due to sloped fill.
- (4) Loading surcharge if any.
- (5) Hawser load.
- (6) Lower pool in lock chamber.
- (7) Uplift as defined by water elevations.

b. Case 2 A - with drawdown operating conditions (unusual). The same requirements as for Case 1 are included except for the following conditions:

- (1) Lower pool drawn down.
- (2) Extreme low-water stage.

c. Case 2 B - with drawdown ineffective operating condition (unusual). The same requirements as for Case 1 are included except for the condition of the raised saturation level caused by ineffective drain or ponding.

d. Case 2 C - maintenance condition (unusual). The same requirements as for Case 1 are included except for the following conditions:

- (1) Lock chamber unwatered to a predetermined level.
- (2) No hawser load.

e. Case 2 D - emergency conditions (unusual). The same requirements as for Case 1 except for the condition of an earthquake load added in the most critical direction.

f. Case 3 A - construction conditions (unusual). The requirements include:

- (1) Moist backfill to a predetermined height.
- (2) Permanent or construction surcharge.
- (3) Wind as applicable.
- (4) No uplift.

g. Case 3 B - construction condition with cofferdam (unusual). The same requirements as for Case 3 A are included except for the condition that hydrostatic forces are active instead of moist earth in accordance with construction and cofferdam plans.

B-4. Design Loading - Lock Chamber River Wall

a. Case 1 A - normal operating (usual) condition.
The requirements are as follows:

- (1) Upper pool in lock chamber.
- (2) Lower pool outside, if dam is upstream of section.
- (3) Uplift as defined by water elevations.
- (4) Vessel impact.

b. Case 1 B - normal operating (usual) condition.
The requirements are as follows:

- (1) Lower pool in lock chamber.
- (2) Upper pool outside, if dam is downstream of section.
- (3) Uplift as defined by water elevations.
- (4) Hawser loads.

c. Case 2 A - operating condition with drawdown (unusual). The same requirements as for Cases 1 A and 1 B are included except for the following conditions:

- (1) Applicable pool drawn down.
- (2) Extreme low-water stage for lower pool only.

d. Case 2 B - maintenance condition (unusual). The same requirements as for Cases 1 A and 1 B are included except for the condition of a lock chamber unwatered to a predetermined level.

e. Case 2 C - emergency condition. The same requirements as for Cases 1 A and 1 B are included except for the condition of an earthquake load added in the most critical direction.

f. Case 3 - construction condition (unusual). The requirement is that hydrostatic forces are active in accordance with construction or cofferdam plans.

B-5. Design Loading - Lock Chamber Intermediate Wall

a. Case 1 A - normal operating condition (usual).
The requirements are as follows:

- (1) Upper pool in main lock.
- (2) Lower pool in auxiliary lock or outside of lock downstream of auxiliary lock.
- (3) Uplift as defined by water elevations.
- (4) Hawser load in auxiliary lock.
- (5) Vessel impact in main lock.

b. Case 1 B - normal operating condition (usual).
The requirements are as follows:

- (1) Upper pool in auxiliary lock.
- (2) Lower pool in main lock.
- (3) Uplift as defined by water elevations.
- (4) Hawser load in main lock.
- (5) Vessel impact in auxiliary lock.

c. Case 2 A - operating condition with drawdown (unusual). The same requirements as for Cases 1 A and 1 B are included except for the following conditions:

- (1) Applicable pool drawdown.
- (2) Extreme low-water stage for lower pool only.

d. Case 2 B - maintenance condition (unusual). The same requirements as for Cases 1 A and 1 B except for the following conditions:

- (1) Applicable lock chambers unwatered to a predetermined level.
- (2) No impact.

e. Case 2 C - emergency condition (unusual). The same requirements as for Cases 1 A and 1 B except for the following conditions:

- (1) Earthquake load added in most critical direction.
- (2) No impact.

f. Case 3 - construction condition (unusual). The requirement is that hydrostatic forces are active in accordance with construction or cofferdam plans.

B-6. Design Loading - Upper and Lower Gate Bays

a. Case 1 A - normal operating condition (usual) - gate loaded. The requirements are as follows:

- (1) Gates mitered.
- (2) Upper pool upstream of gates.
- (3) Lower pool downstream of gates.
- (4) Applicable wall loadings as defined in paragraphs C-3, C-4, and C-5.

b. Case 1 B - normal operating condition (usual) - gates unloaded. The requirements are as follows:

- (1) Gates swinging free in approximate mitered position.
- (2) For upper gate bay, upper pool in gate bay.
- (3) For lower gate bay, lower pool in lock chamber.
- (4) Applicable wall loadings as defined in paragraphs C-3, C-4, and C-5.

c. Case 2 B - operating conditions with drawdown (unusual). The same requirements as for Cases 1 A and 1 B are included except for the following conditions:

- (1) Pools in lock chamber or lock entrance drawn down or with extreme low-water stages.
- (2) Uplift as defined by water elevations.

d. Cases 2 C and 2 D - operating drains ineffective condition (unusual). The same requirements as for Cases 1 A and 1 B are included except for the condition of the raised saturation level caused by ineffective drains or ponding.

e. Case 2 E - maintenance condition (unusual). The same requirements as for Case 1 B are included except for the following conditions:

- (1) Lock chamber unwatered to a predetermined level.
- (2) Uplift as defined by water elevations.

f. Cases 2 F and 2 A - emergency condition (unusual). The same requirements as for Cases 1 A and 1 B are included except for the condition of earthquake loads added in most critical direction.

g. Case 3 A - construction condition (unusual). The requirements are as follows:

- (1) Moist backfill to a predetermined height.
- (2) Permanent or construction surcharge.
- (3) Wind as applicable.
- (4) No uplift.

(5) Gates swinging free in appropriate mitered position.

h. Case 3 B - construction with cofferdam condition (unusual). The same requirements as for Case 3 A are included except for the condition that hydrostatic forces are active instead of moist earth in accordance with construction and cofferdam plans.

B-7. Design Loading - Upper and Lower Approach Walls

a. Case 1 - normal operating condition (usual). The requirements are as follows:

- (1) Upper or lower pool on face of wall as applicable.
- (2) Saturated fill.
- (3) Upper or lower pool on back face of wall as applicable.
- (4) Boat impact on face of wall at most critical angle of incidence and force.
- (5) Hawser pull away from face of wall as applicable.
- (6) Uplift as defined by water elevations.

b. Case 2 - operating condition with earthquake (extreme). The same requirements as Case 1 are included except for the following conditions:

- (1) Earthquake in most critical direction.
- (2) No impact or hawser pull.

c. Case 3 - construction condition (unusual). The requirements are as follows:

- (1) Moist backfill.
- (2) Permanent or construction surcharge.
- (3) Wind as applicable.
- (4) No uplift.

B-8. Design Loading - Upper and Lower Sills

a. Case 1 - normal operating condition (usual). The requirements are as follows:

- (1) Upper pool upstream of gate.
- (2) Lower pool downstream of gate.
- (3) Fill or silt to top of sill on upstream side.

(4) Applicable gate loads for vertically framed miter gates and rolling gates.

(5) Uplift and vertical water loading as defined by water elevations.

b. Case 2 A - operating condition with drawdown (unusual). The same requirements as for Case 1 are included except for the following conditions:

- (1) Lower pool drawdown.
- (2) Extreme low-water stage.

c. Case 2 B - maintenance condition (unusual). The requirements are as follows:

- (1) Upper pool upstream of temporary closure structure.
- (2) Lock chamber unwatered.
- (3) Uplift and vertical water loading as defined by water elevations.

Appendix C Semiautomatic Central Control System

C-1. Central Control System

The essential feature of a automated system to achieve the objectives for safer, more efficient lock operation should include a centralized control house, located central to the lock operations and providing high visibility for operating equipment and navigation approaches. The central control system should consist of a computer system interfaced with programmable logic controllers (PLC's). The following paragraphs describe the salient features of the operational design for automation of Melvin T. Price Locks and Dam using PLC's. Design assumptions, criteria, and characteristics of each of the following systems are presented as an example of a functioning system installed in 1992.

a. Programmable logic controllers (PLC's). The PLC system for the lock will serve several functions. First, the PLC is the heart of the lock equipment controls. The logic, timing, counting, latching, and interlocking required to control the lock gates, valves, and auxiliary equipment will be contained within the PLC. Secondly, the PLC will serve as a multiplexer. Inputs and outputs will be wired to the PLC very efficiently. Significant wiring and conduit costs will be avoided by taking advantage of the PLC multiplexing ability. Finally, the PLC will be an interface device between the lock operators' industrial personal computers (IPC's) and the outside world. The PLC will monitor data from geographically diverse points and send it to the IPC's for display. The PLC will also accept commands from the computers and activate external equipment in response.

(1) PLC architecture. The PLC will consist of a central processor and four remote input/output (I/O) racks. Each I/O rack is geographically located to minimize the wiring to the devices that it monitors and controls. The I/O racks will communicate with the processor by means of fiber optic links, offering very high speed and electrical noise immunity.

(2) PLC interface. The PLC processor will communicate with the IPC's via a fiber optic network interface. The PLC will communicate the status of all monitored devices to the IPC's via this interface. The PLC will also receive commands from the IPC's on the interface. The logic within the PLC may be actuated by commands from the IPC'S or by inputs to the PLC from pushbuttons located in the local control houses.

(3) PLC system reliability. System reliability will be assured by using industry tested PLC's in a simple configuration. Backup processors and automatic switching of equipment at the PLC level, while commercially available, are not recommended for this application. Outages are infrequent and repairs can be quickly executed. Additionally, the emergency controls will allow lock operation even during PLC failure. Redundant processors add significant expense and additional equipment and wiring to fail. The power to the PLC will be backed by the lock emergency generator. Battery-powered memory modules in the processor and I/O racks will protect PLC memory until power is restored.

b. Industrial personal computers system (IPC's). The computer system for control and monitoring of the lock and dam will be located in a control console in the central control house (Figure C-1). The computer system will serve several functions:

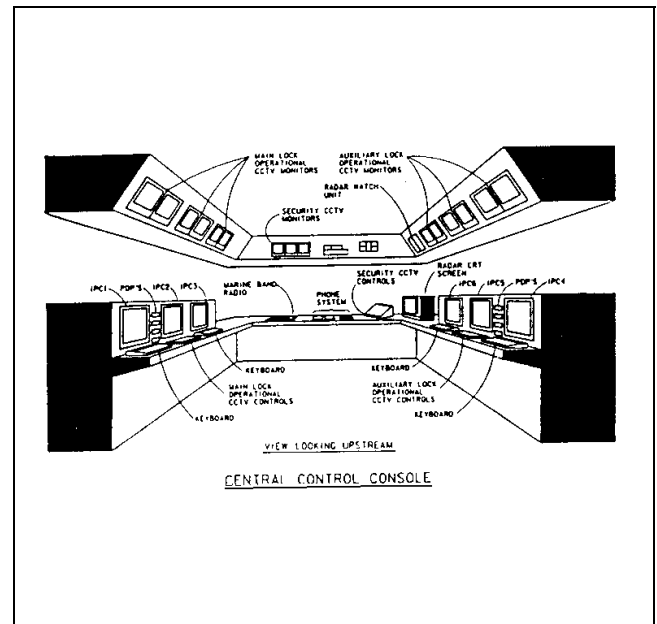

Figure C-1. Central control house operating console

(1) Operator interface. The computers will present and accept data and commands in a format conducive to human comprehension.

(2) Command device. The computers will initiate commands to the PLC's to control equipment throughout the lock and dam.

(3) Warning/diagnostics. Abnormal conditions will be annunciated to the operators, as well as diagnostic

messages of explanation. Operation and maintenance information of critical equipment will be stored for quick retrieval. Emergency instructions will be displayed.

(4) Data validity checks. The computers will check the operator commands for validity and alert the operator if an abnormal input is attempted.

(5) Data archives. Data relating to barges, lock operation, and fire alarms will be monitored and recorded (hard copy) for permanent records.

(6) Pool regulation. The logic for automatic control of the upstream pool level will be done within the computer system.

c. Computer system. The computer system hardware will consist of two completely independent subsystems, one for each lock. Each subsystem will comprise three industrial-quality personal computers (with appropriate interface cards), three color Cathode Ray Tube (CRT) monitors, three keyboards, and four programmable display pushbuttons (PDP's). The two subsystems will share a printer for hard copies.

(1) Computer program. The computer system will control two of the three possible modes of operation. Operating modes will include semiautomatic, manual, and emergency. In the semiautomatic mode, the first computer will use the PDP's to prompt the operator through a lockage sequence. The computer will handle many of the intermediate steps that do not require human intervention. In the manual mode, the operator will execute a lockage by selecting numbers from a menu, using the keyboard of computer number one. The operators individually initiate each step, such as opening a valve and then monitoring lock chamber levels. An operator may execute the same series of steps in the manual mode by means of push-buttons located in any of the four local control houses. In the emergency mode, the computers and programmable controllers will not be involved; control will be affected by means of hard-wired overrides at the local control houses.

(2) Control menus. In the semiautomatic mode of control, the operator will initiate sequences using the PDP's. The IPC's and PLC will automatically sequence the events that do not require human intervention and prompt the operators via the PDP's. In the manual mode, the operator will initiate an action using a keyboard and color CRT monitor (or pushbuttons in the local control houses). Actions may be selected from a series of

"Menus" that will appear on the color monitor; this mode of control is also referred to as the "Menu Control." The operator will initiate a device by simply selecting a number corresponding to the desired action from the monitor, typing the number on the keyboard, and then pressing the return key on the keyboard. The graphics menu will display the following "Graphic Display Window Selection."

- (a) Upstream miter gate control.
- (b) Filling valve control.
- (c) Downstream miter gate control.
- (d) Emptying valve control.
- (e) Upstream hydraulic system bypass control.
- (f) Downstream hydraulic system control.
- (g) Traffic light control.
- (h) Strobe light and warning horn control.
- (i) High mast lighting control.
- (j) Emergency miter gate fire protection.
- (k) Spillway gate control.
- (l) Return to mode menu.
- (m) Valve and gate interlock bypass.

(3) Data collection requirements. Operations of the lock and dam requires constant record keeping. Record keeping currently occupies a large percentage of the operator's time. The use of IPC's for controls offers an opportunity to streamline record keeping while improving record quality and reducing the load on the operator. Record keeping may be broken into three categories; daily, shift changes, environmental conditions, and lockage information. It is proposed that daily records be entered using the IPC's dedicated for record keeping.

(a) The operator will manually enter such daily data as precipitation and the ice code and details.

(b) Shift change records occur at the beginning of each new shift. Using the IPC's, the operator will manually enter the following shift change data:

- Lock operator number.
- Number of vessels waiting above and below.
- Upper and lower pool current condition.
- Weather code and severity.
- Surface code and severity.
- Wind direction and velocity.
- Flotilla length and width.
- Maximum barge draft.
- Number of barges loaded and empty.
- Barge type.
- Commodity code and tonnage.
- Chamber number.

(c) Using one special-function keystroke, the operator will then direct the computer to automatically record the following data:

- Lock number.
- River.
- Date.
- Time and time zone.
- Air temperature.
- Water temperature.
- Upper and lower pool elevations.
- Spillway gate settings.
- Record number.
- Number of cuts.
- Type of lockage.
- Number of light commercial boats.
- Number of recreational vessels.
- Number of passengers.
- Entry type.
- Exit type.
- Stall code, and (optional) date and time.
- Tow stop since last lockage.
- Type of assistance, if any.
- Arrival (date and time).

(d) The IPC's can also significantly improve the manner in which the IPC's will be networked with district or regional computers via modems or fiber optic networks. (An electronic mail system can also be established between the locks and the district.) The network will allow the interchange of data between locks and the generation of reports that are not lock-specific. For each lockage, the operator will access a database and automatically record the following data:

- Vessel name.
- Vessel number.
- Vessel type.
- Directions.
- Origin.
- Destination.
- (e) The IPC's will reduce operator workload by assisting the operator in logging the time of occurrence of some of the following lockage events:
 - Start of lockage-first cut.
 - Bow over sill-first cut.
 - End of entry-first cut.
 - Start of exit-first cut.
 - End of lockage-first cut.
 - Start of lockage-second cut.
 - Bow over sill-second cut.

- End of entry-second cut.
- Start of exit-second cut.
- End of lockage-second cut.

(f) The IPC's will generate reports also by providing hard copies via the printer in the central control house. Information for some of the reports can be obtained from the network links to other locks in the Navigation System. The following reports will be generated:

- Morning ice report (information on navigation conditions).
- RPT01 - Lockage & Tonnage Summary.
- RPT03 - Daily Detail Lockage Report.
- RPT04 - Locate a Single Vessel.
- RPT07 - Lockage & Tonnage Summary.
- RPTIO - List Vessel Names.
- HRE01 - Weather Screen.
- HRE02 - Lock-Gate-Stage Screen.
- HRE03 - Lock Daily Hydraulics Report.
- HRE07 - Degree-Day.

- HRE08 - River Current Stage.
- Vessel log.
- Shift log.
- Lockage log.

C-2. Control Console Layout

The central control console will be located in the control room of the central control house. The console will house computers and support equipment and will permit an operator to control the entire dam and locks from one point.

C-3. Automatic Pool Regulation System

The automatic pool regulation system is a control system designed to regulate upstream pool elevation. This system will control all spillway gate movement and permit accurate control of pool elevation without operator intervention. The system will sense any abnormal conditions and alert the operator if human intervention is needed. The controls will also permit an operator to manually control individual spillway gates or shut down a gate for maintenance. Lock gates, culvert valves, and spillway gates may still be controlled by hard-wired local control stations at the local operating stations if equipment failure renders this necessary. The control system was designed to operate in five modes: initialize, automatic, manual, manual with setpoint, and maintenance.

Appendix D Case Histories

D-1. Markland Incident of 1967

This incident resulted from a barge tow breaking loose from an upstream mooring (tied to a tree on the bank that pulled out) and floating into the dam. The barges sank in the dam gate bays with some of the barges wrapping around the piers; thus the tainter gates were prevented from closing during a return from open river conditions. The resulting loss of pool caused major damage to harbors, stranded boats, sloughing highway embankments, water intakes, and sewer outfalls. Figure D-1 shows the removal of the barge from the Markland Lock and Dam. Based on this incident, the Corps developed recommendations for design guidance.

D-2. Summary of Recommendations

The following edited version of the recommendations contains guidance that relates to the lock and dam design and operation.

a. Prevention of accidents - lock and dam.

(1) Recommend installing remote control systems to provide for operation of spillway gates from the operations building.

(2) Recommend that Corps of Engineers Regulations prohibit operators from mooring unattended tows within 10 river miles upstream of a dam, except at commercial docks, bonafide mooring facilities, government furnished mooring facilities, or fleeting areas.

(3) Recommend installation, for tows awaiting lockages, mooring facilities both upstream and downstream of navigation structures.

(4) Recommend each district institute training programs for lock and dam personnel to familiarize them with types of decisions made in emergency situations.

b. General recommendations.

(1) Recommend the Corps of Engineers establish formal liaison and participate with the Coast Guard, other federal agencies, and Navigation Industry Groups in public deliberations and studies concerning the enforcement of safe navigation on the canalized rivers.

(2) Subjects that may be discussed by these and other bodies which could significantly influence the Corps' plans for protection of its navigation structures and on which the Corps' views should be made known include the following:

(a) The analysis of requirements for permanent mooring facilities between dams.

(b) The development of more specific regulations affecting mooring procedures.

(c) Regulation of the size and power of tows to assure safe control of the movement of the tows under any reasonably anticipated river conditions.

(d) Coast Guard examination and licensing of selected personnel on towboats and self-propelled barges.

(e) Mechanical inspection of towboats by the Coast Guard.

c. Engineering modifications. Recommend engineering and economic feasibility studies for installation of protective barriers, lengthened guide walls upstream of dams, or modification of piers to prevent major damage to structures by runaway tows.

d. Recovery operations - equipment.

(1) Recommend procurement of a whirler-type derrick-boat of approximately 300-ton capacity to be based at the Service Base.

(2) Recommend for each district the provision (either by modification or procurement) of a towboat of sufficient thrust and size to facilitate handling of floating plant that would be used in a recovery operation.

(3) Recommend each district fabricate or procure effective power-driven cutting beams to separate barges wrapped around the dam pier structures.

(4) Recommend technical assistance from the Office, Chief of Engineers, and other engineer agencies, such as Engineer Research and Development Laboratories, to determine feasibility of utilizing explosive anchors for emergency mooring of recovery rigging to the lock and dam structures.

(5) Recommend each district examine its capabilities to ensure the following:

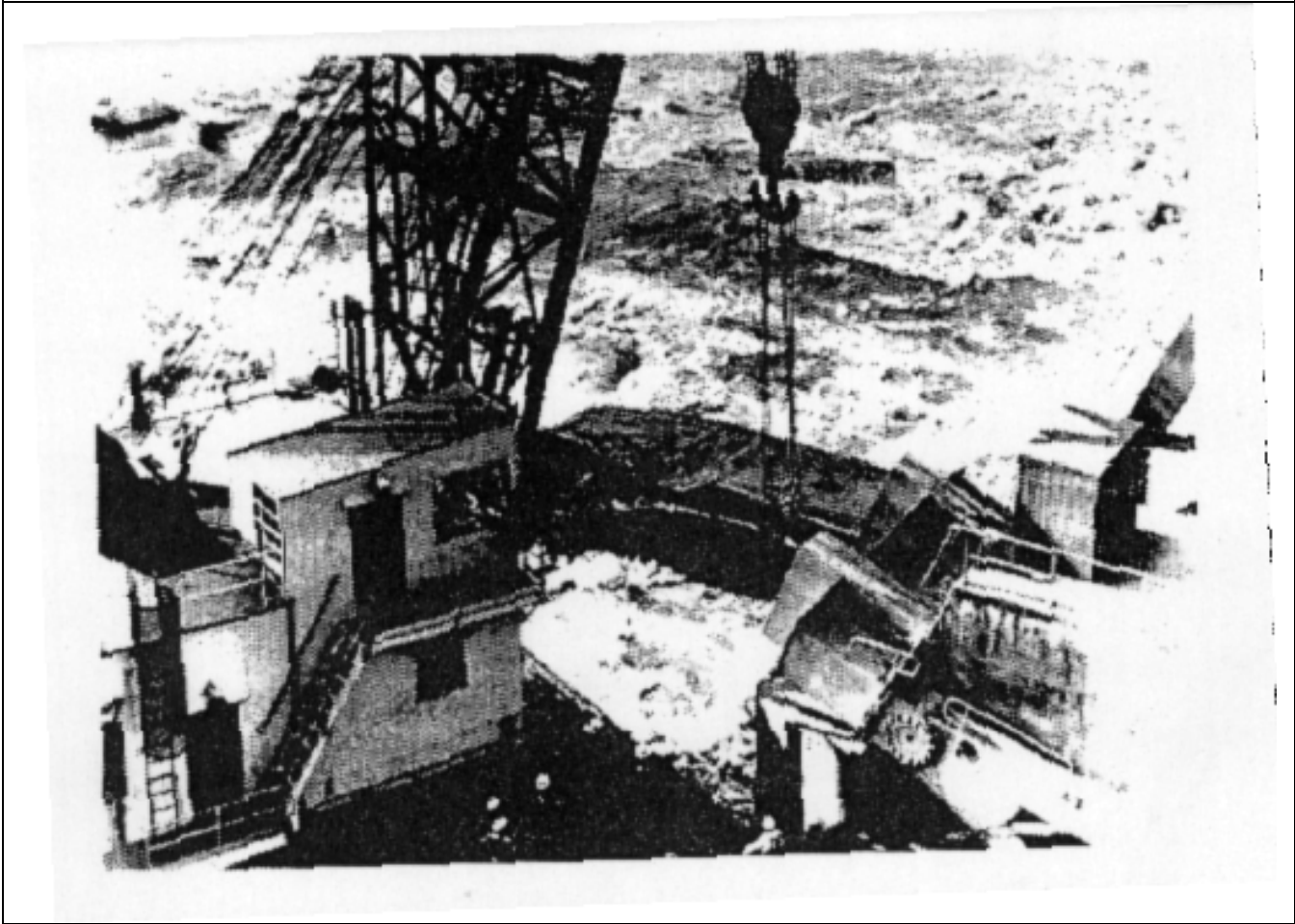

Figure D-1. Removal of barge wrapped around dam pier - Markland Lock and Dam, Ohio River, 1967

(a) Capability for rigging of heavy wire ropes and chains and for underwater cutting of steel by torch.

(b) Development of sounding techniques to accurately determine the underwater positions of sunken barges and obstructions.

(c) Provision of heavy anchors, and provision of suitable anchor derrick and winch barge for use in safely positioning floating plant above dam.

(d) Supply of assorted heavy slings and haul cables with suitable terminal fittings and quick-release devices.

(e) Development of grappling devices and techniques for quick attachment of haul cables to submerged barges not accessible for conventional attachment.

(f) Development of equipment and techniques for quick introduction of compressed air into sunken barge compartments.

(g) Provision of adequate radio communications during recovery operations between government, navigation, and contractor interests.

e. Modification of lock and dam structures.

(1) Recommend provision of adequate facilities on river walls, piers, and abutments both upstream and downstream of navigation structures for positioning floating plant and for rigging during recovery operations.

(2) Recommend design and procurement of special lifting beams for use with overhead bulkhead cranes.

(3) Recommend engineering and economic and feasibility studies to provide for more versatile use of the overhead piggy-back cranes to increase the capacity to 50 tons and to include clamshell bucket operation and lowering of personnel to work areas.

(4) Recommend engineering and economic feasibility studies for preinstallation of chain slings in gate bays to expedite removal of objects with bulkhead crane.

(5) Recommend each district install anchor bolts on river wall immediately upstream of the dams to facilitate timely installation of portable winches.

f. Organization.

(1) Recommend each district organize a marine disaster recovery team to ensure adequate supervision of three-shift recovery operations over an extended period.

(2) Recommend each district have a trained, experienced Technical Liaison Office as a single point of contact for coordination of public information activities during emergencies.

(3) Recommend each district maintain a current list of marine contractors and contractors' equipment available for possible use in marine disaster recovery operations.

(4) Recommend that periodic seminars be conducted with key personnel, such as Chiefs of Branches and Construction Resident Engineers, reviewing plans and capabilities and preestablishing key emergency team members for recovery operations.